



read catalogue
online:



Otto Oehme GmbH
Industriestr. 20
90584 Allersberg
Germany

Hotline: +49 (0) 9176 / 98 05 0
Fax: +49 (0) 9176 / 98 05 55
E-mail: info@oehme-lorito.de
www.oehme-lorito.de

CLEANING SYSTEMS, AUXILIARY EQUIPMENT, CLEANING MACHINES



read catalogue
online:



Otto Oehme GmbH
Industriestr. 20
90584 Allersberg
Germany

Hotline: +49 (0) 9176 / 98 05 0
Fax: +49 (0) 9176 / 98 05 55
E-mail: info@oehme-lorito.de
www.oehme-lorito.de

CLEANING SYSTEMS, AUXILIARY EQUIPMENT, CLEANING MACHINES

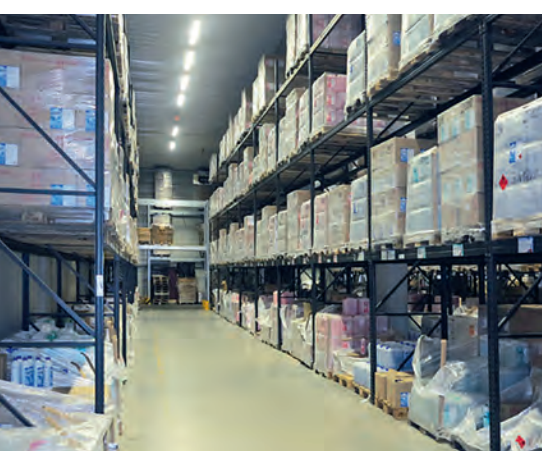

Content

Mopping Systems	7
Glass Cleaning	8
Moist Mops	9
Special Wet Mops	10
Wet Mops and Bucket Systems – Single Bucket Systems	12
Wet Mops and Bucket Systems – Double Bucket Systems	14
Wet Mops and Bucket Systems – Mopping Carts	16
Auxiliary Equipment and Accessories	17
Cloths, Sponges, Pads	18
Plastic Buckets & Bags	19
Brushes & Brooms	20
Other Equipment	22
Sanitary Equipment and Accessories	23
Hygienic Paper & Dispensers	24
Soap Dispensers	25
Other Accessories	26
Cleaning & Hotel Trolleys	27
Vacuum Cleaners	33
Vacuum Cleaners	34
Wet and Dry Cleaners	36
Upright Vacuum Cleaners	38
Accessories for Vacuum Cleaners	39
Cleaning machines	41
Single Disc Machines	42
Spray Extraction Machines	44
Scrubber Dryers	45
QR Codes in this Catalogue	4
Product List	5
Overview: Mop Materials	47
Distribution Network	48
Index	51



QR Codes In This Catalogue

Get product information faster and more precise

QR codes ("quick response") are two-dimensional bar codes which enable quick access to the internet via a camera of a smartphone or tablet. A QR code reader installed on the device is required but you can get one on the internet for free.

Benefits of QR codes

As the name suggests the QR code directs the user straight to the product page in the Oehme Lorito download centre. There you can access and download all information on a certain product quickly and easily. On the particular product page you can find all available safety and product data sheets and a picture as well as characteristics and operating instructions.



Use of QR codes in this catalogue



A | If this has not yet been done, install a QR code reader on your smartphone or tablet. You can find app recommendations with shortlinks to download them in the infobox beneath.

i

QR code reader for Apple iOS:

„Scan“ for Phone, iPad, iPod touch

„QR Reader for iPhone“ - free

„QR Reader for iPad“ - free

<http://oehme-lorito.de/qr-ios>

<http://oehme-lorito.de/qr-iphone>

<http://oehme-lorito.de/qr-ipad>

for Android:

„Barcode Scanner“ - free

<http://oehme-lorito.de/qr-android>



B | Scan the QR code next to the desired product in the catalogue with the app. You are then directed to the product page in the Oehme Lorito download centre. There you can directly access and download safety and product data sheets.



C | In case of problems concerning the use of QR codes you can also open the Oehme Lorito download centre in the browser of your mobile phone or computer manually:

1. Go to <http://www.oehme-lorito.de>.
2. There is a search window on the welcome page where you need to Type in the name of the product, the number or the webcode (e.g. #2d2d)
3. Click / tap on "search"
4. Open the product page by clicking / tapping on the product name or picture.

Product List

2-chamber bucket	16	Jumbo roll mount	24	Single chromed	12
Accessories for window cleaners	8	Latex gloves	22	Soap dispenser	25
Adaptor for Hitachi nozzles	39	Laundry trolley „Steve“	32	Socket cleaning brush	26
BF 520	43	Level-duo	15	Special mops	10
BF 521	42	Lorito Baby	35	Special mops microfibre	11
BF 584 A-3 with suction cart	37	Lorito Profi	34	Sponges	18
Brooms 1-hole-system	20	Lorito Silent 10 / 15	34	Spray cans	22
Brooms and brushes powerstick	20	Lorito SW 38	36	Spray extraction machine	44
Brooms and brushes 4-hole	20	Lympia 13	43	Suction tubes	40
Bucket systems	15	Metal scraper	22	Superpads	18
Blade holder	8	Microfibre mops	10	SW 30 Cleanair	37
		Microfibre special mops	10, 11	SW 55 Cleanair	37
C 143 OLN	42	Microfibre towels	18	SW 75 Cleanair	37
C 143 TSN two speed	42	Minispeed 350E/B	46	SW 93	36
C 150 L 16	43	Moist mops	9	Telescopic handles	8
C 150 U 13	42	Moist wiping frames	9	Thommy, Thommy Duo	31
Cartridges for soap dispenser	25	Mopping cart „Maxi“ with press	16	Tool handles	20
Caution signs	22	Multipurpose tool	39	Tool handles 4-hole	20
Cleanfix S10 Plus	35	Paper filters	40	Toilet brush	26
Cleaning trolley „Max“	30	Paper towel dispensers	24	Turbo nozzle	39
Cleaning trolley „Willy“	30	Paper bins	26	Two-roll cleaning machine	45
Cloths	18	Parquet tool	39	Urinal deodorizer	24
Crevice nozzles	39	Parquet mops	9	Washer sleeves	8
Combined floor tools	39	Plastic buckets, rectangular	19	Waste bin	26
		Plastic buckets, round	19	Waste picker	22
Deodorizer clips	24	Plastic bags / bin liner	19	Waste trolley X-form	32
Deodorizer „Curve“	24	Pumie dirt remover	26	Water mover	21
Disinfectant troughs	19	Power cables	40	Wet mops	11
Double bucket systems	14, 15	Quick mops	11	Wet mop x-mount	9
Duo chromed	14	Quiver for tools	8	Window washer	8
Duo frame foldable	15			Window washer holder	8
Duo plastic	14	RA 300 E	45		
Duo plastic „KURT“	14	RA 431 B	45		
Dustpan and broom	20	RA 431 E	45		
		RA 501 B	45		
Feather duster	21	RA 501 E	45		
Floor and ceiling brushes	21	RA 605 IBCT	46		
Floor and window scraper	8	Riloto peach soap	25		
Foam soap dispensers	25	Roll press system	16, 19		
Folding flat mop frames	11	Ruck Zuck knapsack exhauster	38		
Fork mops	22				
Fuginator	26	Sabrina	44		
Funnel tube	26	Sabrina maxi	44		
		Sanitary brushes	21		
Gaze cloths	9	SEBO 36 Comfort	38		
Glass cleaning cloths	8	SEBO 46 Comfort	38		
Gloves	22	Serie 105	28		
		Serie 106	28		
Handpads & holder	18	Serie 107	28		
Heater brush	21	Serie 108	29		
HERWE Cura skin care	26	Serie 203	29		
Hitachi CV-300, CV-300 P	34	Serie 204	29		
Hitachi CV-400	34	Serie 209	15		
Hitachi CV-950 BK	35	Shoepads	18		
Hose set complete	39	Single chromed, foldable	13		
Hotel trolleys	32	Single plastic	12		
HS 2000	43	Single plastic „KURT“	12		
Hygienic pouches and dispenser	24				
Hygienic paper	24				

Four-Colour-System

Mix-up impossible – one colour for each application

The well-established Four-Colour-System ensures hygiene while cleaning surfaces above the ground. The colour system allows an easy optical separation of cleaning equipment like cloths, sponges, buckets or cleaning agents. An consequent application of this colour system not only optimises hygiene, but also simplifies the cleaning management.

The system consists of four basic colours: red, yellow, blue and green, whereat each colour represents an specific application area. Thus it avoids the usage of a cloth, that has been used for the toilet before, for cleaning the desk and therefore transmitting germs to furnishings.

The following colour codes are well-established in practice:



Sanitary areas (toilet, urinal)

for sanitary areas with high bacterial contamination like toilets, urinals, bidets and its splash zones. Hygiene has the highest priority in these areas.



Sanitary areas (other areas)

for the general sanitary areas, which have a lower bacterial contamination, like sinks, mirrors, bathtubs, taps. To avoid bacterial dissemination to other, non-sanitary areas.



General cleaning

for the general cleaning of surfaces like furnishings, doors, lamps and windows in the office or lobby.



Kitchen/special assignment

for areas that encounter food like kitchens, cafeterias and recreation rooms. Also suitable for special assignments like operation rooms, glass cleaning or floors.

Every public space like schools, kindergardens, day-care centres and hospitals is obligated to use a colour system for separation.



MOPPING SYSTEMS

Glass Cleaning

Window cleaners

stainless steel, with rubber



Item No.	Item	Size
401225	blue	25 cm
401235	blue	35 cm
401245	blue	45 cm
401255	blue	55 cm
454125	black	25 cm
454135	black	35 cm
454145	black	45 cm
454155	black	55 cm
403030	2-in-1 combo	25 cm

Window washer holder



Item No.	Item	Size
457408	plastic, black	25 cm
401030	plastic, blue	35 cm
401031	plastic, blue	45 cm
457501	plastic, black	55 cm

Blade holder



Item No.	Item	Size
456600	blade holder patented	10 cm
456400	blade	10 cm
466807	ceramic glass scraper	4 cm

Floor and window scraper

with plastic grip



Item No.	Item	Size
401090	working width 10 cm	22 cm
401091	working width 10 cm	120 cm
466900	special scraper	10 cm

Telescopic tube aluminium

exchangeable conus, black handle



Item No.	Item	Size
A 455610	two-piece, 2,5 m	2x1,25 m
A 455710	two-piece, 4 m	2x2,00 m
A 455810	three-piece, 6 m	3x2,00 m
A 455910	three-piece, 9 m	3x3,00 m

Accessories

B 449910	conus for telescopic tube
C 456200	universal clip metal, suitable for telescopic tube with exchangeable conus
D 459290	wall and ceiling broom, attachable on telescopic tube

Accessories for window cleaners



Item No.	Item	Size
401070	rubber strip, black	25 cm
401071	rubber strip, black	35 cm
401072	rubber strip, black	45 cm
454501	rubber strip, blue	35 cm
454601	rubber strip, blue	45 cm
454801	rubber strip, blue	105 cm

Washer sleeves

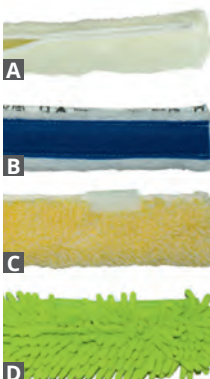

Item No.	Item	Size
A 457201	white	25 cm
A 401040	white	35 cm
A 401041	white	45 cm
A 457200	white	55 cm
B 457001	blue with pad	35 cm
B 457101	blue with pad	45 cm
B 457102	blue with pad	55 cm
C 456701	super quality	35 cm
C 456801	super quality	45 cm
C 456702	super quality	55 cm
D 457225	chenille	25 cm
D 457235	chenille	35 cm
D 457245	chenille	45 cm

Quiver for tools

for window washer, cleaners etc.



Item No.	Item
457602	quiver, plastic
454412	belt for quiver

Glass cleaning cloths

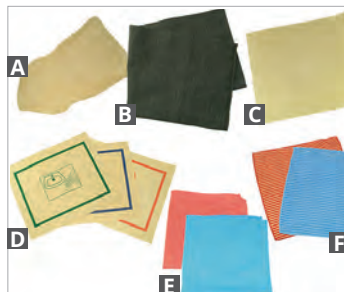

Item No.	Item	Size (ca.)
A 669101	chamois leather (6 qfs)	85x70 cm
B 457600	emery cloth	60x70 cm
C 651711	professional room care cloth, perforated, super quality	35x40 cm
D 651712	professional room care cloth with pictogram, red, green, blue	35x40 cm
E 453702	window cloth, ripped microfibre, blue, red, green	40x40 cm
F 453718	Lorito Bambu, red	40x40 cm
F 453719	Lorito Bambu, blue	40x40 cm
453714	Flauschi, blue, red, green, yellow	40x40 cm

Moist Mops



Moist mop covers with polyester back

cotton, washable at 50°

Item No.	Item	Size
B 461401	with bags	40 cm
A 461503	with ribbon	60 cm
B 461502	with bags	60 cm
B 461602	with bags	80 cm
A 461603	with ribbon	80 cm
A 461700	with ribbon	110 cm
A 461801	with ribbon	130 cm
C 461912	with ribbon	160 cm



Moist mop Item No. 419000
blue, Synthetic, 60 cm, washable at 60°
other sizes on demand



Moist wiping frames

Item No.	Item	Size
460900	plastic	60 cm
461000	plastic	80 cm
461100	metal	110 cm
461200	metal	130 cm
461300	metal	160 cm



Gauze cloths
for moist mops with central hole, seamed

Item No.	Item	Size (ca.)
463000	gauze cloth	80x60 cm
463100	gauze cloth	80x90 cm
463200	gauze cloth	80x120 cm
463300	gauze cloth	80x150 cm
463400	gauze cloth	80x180 cm



Special cleaning cloth

Item No.	Item	Size (ca.)
437200	cloth with high dirt holding capacity, yellow	60x60 cm
437300	cloth with high dirt holding capacity, yellow	22x60 cm
437350	cloth with high dirt holding capacity, yellow	60x25 cm
437100	trapeze mop, blue	60 cm



Trapeze mop

Item No.	Item	Size
437100	trapeze mop	60 cm
437110	trapeze mop with hook-and-loop tape, for window cleaning	30x8 cm
444045	hook-and-loop mop 80% polyester, 20% polyamide, washable up to 60°C	30x10 cm



Special wet mop X-mount

Item No. 416800

Accessories	
416900	wooden rack, 2x110 cm
416910	handle with metal stirrup
417000	cotton cover, 110 cm



Parquet mops

100% polyester, black/white mottled, washable up to 95°C

Item No.	Item	Size
471500	with bags	60 cm
471600	with bags	80 cm
471400	with fringe	40 cm
471300	with fringe	60 cm
471200	with fringe	80 cm

Special Wet Mops



Special mop "Ida"

washable at 95°, polyester back and bags, with soft inlays

Item No.	Item	Size
443660	mesh/fringe	40 cm
443670	mesh/fringe	50 cm



Special mop "Carola"

washable at 60° C, polyester back and bags, green fringe ribbon, 230 g

Item No.	Item	Size
414230	mesh/fringe	40 cm
414240	fringe/fringe	40 cm
414250	mesh/fringe	50 cm
414260	fringe/fringe	50 cm



Special wet mops tufted

50% cotton / 50% polyester

Item No.	Item	Type	Size
A 414380	"First"	tufted	40 cm
A 414385	"First"	tufted	50 cm
B 414390	"Second"	tufted	40 cm
B 414395	"Second"	tufted	50 cm



Microfibre special mop chenille "Professional", "Calito"

for wiping, dedusting and polishing

Item No.	Item	Type	Size
447051	chenille "Professional"	blue	40 cm
447052	chenille "Professional"	blue	50 cm
447053	chenille "Professional"	red	40 cm
447054	chenille "Professional"	red	50 cm
447001	"Calito"	blue	40 cm
447002	"Calito"	red	40 cm
447003	"Calito"	blue	50 cm
447004	"Calito"	red	50 cm



Microfibre mops

Item No.	Item	Type	Size
469040	Augustin, plush	white	40 cm
469050	Augustin, plush	white	50 cm
467020	special microfibre mop with grey active-microfibre stripes	white/grey	40 cm
467021	special microfibre mop with grey active-microfibre stripes	white/grey	50 cm
469060	microfibre mop "Augustus" ECO plush	white	40 cm
469065	microfibre mop "Augustus" ECO plush	white	50 cm



Special mop "Carlos"

100 % cotton, with colour coding

Item No.	Item	Type	Size
424240	mesh/fringe	white	40 cm
424250	mesh/fringe	white	50 cm

Special Wet Mops



Special mop microfibre, microfibre "Franzi"

with water depot

Item No.	Item	Type	Size
467040	water depot, blue-mottled, long fibre	112 g	40x12 cm
467041	water depot, blue-mottled, long fibre	152 g	50x14 cm
467044	"Franzi", water depot		40x12 cm
467055	"Franzi", water depot		50x14 cm



Special mop microfibre

with colour coding

Item No.	Item	Size
467057	blue, with colour coding	40 cm
467058	blue, with colour coding	50 cm



Stripe mop

70% polyester, 20% polypropylene, 10% polyamide, washable at 95° C

Item No.	Item	Size
414170	grey-blue	40 cm
414180	grey-blue	50 cm



Quickcovers

PVC/nylon buttstrap

Item No.	Item	Size
418710	mesh/fringe	40 cm
418310	mesh/fringe	50 cm

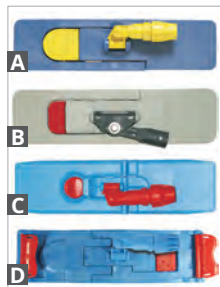

Folding flat mop frames

Item No.	Item	Size
A 443046	magnetic folding flat mop frame, blue/yellow	11x40 cm
A 443047	magnetic folding flat mop frame, blue/yellow	13x50 cm
B 454040	magnetic folding flat mop frame "Petra"	11x40 cm
B 455040	magnetic folding flat mop frame "Petra"	13x50 cm
C 419560	folding flat mop frame for disinfection	11x40 cm
C 419550	folding flat mop frame for disinfection	13x50 cm
D 418550	fast folding flat mop frame "Charly"	11x40 cm
418500	fast folding flat mop frame "Ida"	13x50 cm



Wet mop mounts

Item No.	Item
458201	blue
458202	red
458203	yellow
458204	green



Wet mop I

cotton, with ribbon

Item No.	Item
458400	ca. 390 g
458500	ca. 450 g

other sizes on request

Hint

You find a detailed overview and description of the available mop materials on page 47.

Wet Mops and Bucket Systems – Single Bucket Systems



Single plastic Item No. 469900

Single plastic frame for one bucket (17/25 l) without handle

Item No.	Item	Size
469880	complete	25 l
469881	complete	17 l
469885	with special accessories (see right figure)	17/25 l

Optional Accessories

419801	plastic roller	
K 428100	plastic basket for materials	
N 449700	handle	
A 457810	plastic bucket (red, blue, green, yellow), rectangular, 4 l	
457811	bucket holder for 4 l bucket	
B 459700	plastic bucket (red, blue), rectangular, 25 l	
B 460000	plastic bucket (red, blue), rectangular, 17 l	
T 463610	bag holding frame, 60 l	
463611	holder for bag holding frame and bucket holder	
I 463613	box holder for bottle rack	
464210	stick holder with snap fit	
P 468400	plastic press	
463612	bottle holder/tray	



Mopping cart system "Single Kurt", plastic Item No. 469899

inclusive 1 x 25 l bucket, press K

Optional Accessories

D 469894	plastic shell	
M 469896	handle	



Mopping cart system "Single" chromed Item No. 459900

Single frame chromed for one bucket (17/25 l), roller Ø 75 mm, rubber protection

Item No.	Item	Size
459717	complete with press I	17 l
479717	complete with press P	17 l
459725	complete with press I	25 l
479725	complete with press P	25 l

Optional Accessories

L 459600	handle chromed	
B 459700	plastic bucket (red, blue), rectangular, 25 l	
B 460000	plastic bucket (red, blue), rectangular, 17 l	
P 468400	plastic press	
R 464603	gabion cage for equipment (mounted on handle)	

Wet Mops and Bucket Systems – Single Bucket Systems



Mopping cart system "Single" chromed, foldable

Item No. 459910

chromed, incl. handle

Item No.	Item	Size
459917	complete	17 l
459925	complete	25 l

Optional Accessories

- B 459700 plastic bucket (red, blue), rectangular, 25 l
- B 460000 plastic bucket (red, blue), rectangular, 17 l
- P 468400 plastic press
- R 440472 gabion cage for equipment (mounted on handle) – similar look like figure R, just thinner
- Q 428001 gabion cage, 2 x 5 liter buckets– similar look like figure Q

Accessories for Single and Double Bucket Systems



Wet Mops and Bucket Systems – Double Bucket Systems

**Mopping cart frame "Duo", plastic** Item No. 469800

Duo plastic frame for two buckets (17/25 l) without handle

Item No.	Item	Size
469891	complete	2 x 17 l
469890	complete	2 x 25 l
469895	complete, with optional accessories	2x 17/25 l

Optional Accessories

O 281001	handle	
K 428100	plastic basket for materials	
A 457810	plastic bucket (red, blue, green, yellow), rectangular, 4 l	
457811	bucket holder for 4 l bucket	
C 459311	rectangular bucket with cover	
B 459700	plastic bucket (red, blue), rectangular, 25 l	
B 460000	plastic bucket (red, blue), rectangular, 17 l	
463611	holder for bag holding frame and bucket holder	
J 463612	bag/bottle rack	
I 463613	boxholder for bottle rack	
464210	stick holder with snap fit, Ø 22 mm	
H 464011	plastic rack	
P 468400	plastic press	
306010A	holding frame with cover for plastic bags, 120 l	

**Mopping cart system "Duo Kurt", plastic** Item No. 469898

Incl. 2x25 l bucket, press K, handle and plastic shell/basket for materials

Optional Accessories

B 459700	plastic bucket (red, blue), rectangular, 25 l	
D 469894	plastic shell	
M 469896	handle	

**Mopping cart frame "Duo" chromed** Item No. 459800

Duo frame chromed for two buckets (17/25 l), rolls Ø 75 mm, rubber protection, fixed press holder

Item No.	Item	Size
459817	complete with press I	2 x 17 l
459825	complete with press I	2 x 25 l
479817	complete with press P	2 x 17 l
479825	complete with press P	2 x 25 l

Optional Accessories

440471	plastic basket for materials	
L 459600	handle chromed	
B 459700	plastic bucket (red, blue), rectangular, 2x25 l	
B 460000	plastic bucket (red, blue), rectangular, 2x17 l	
P 468400	plastic press	



Wet Mops and Bucket Systems – Double Bucket Systems

**Mopping cart frame "Duo" foldable** Item No. 459810

chromed, incl. handle

Item No.	Item	Size
459617	complete	2x17 l
459625	complete	2x25 l

Optional Accessories

B 459700	plastic bucket (red, blue), rectangular, 2x25 l
B 460000	plastic bucket (red, blue), rectangular, 2x17 l
P 468400	plastic press
440472	gabion cage for equipment (mounted on handle)

**Mopping cart system "level-duo"** Item No. 464646

basic frame "levelduo" (two-step), plastic trough, gabion cage, plastic press with stick holder and splash guard, 2 x bucket 17 l, blue or red.

Optional Accessories

B 460000	plastic bucket (red, blue), rectangular, 17 l
G 464602	plastic trough
R 464603	gabion cage for equipment (mounted on handle)
P 468400	plastic press

**Mopping cart system "Duo Saggi"** Item No. 450210

basic frame, handle, gabion cage for 2x5 l buckets, rectangular bucket 5 l red and blue, rectangular bucket 17 l red and blue, plastic shell sideways, plastic shell centered, gabion cage sideways.

Item No.	Item
468410	with plastic press P

Optional Accessories

450212	handle
F 450214	plastic shell sideways
E 450213	plastic shell centered
Q 450215	gabion cage, 2 x 5 liter buckets
450216	plastic bucket (red, blue), rectangular, 5 l
S 450217	gabion cage sideways
B 460000	plastic bucket (red, blue), rectangular, 17 l

**Double bucket system - 209 series** Item No. 450209

with press. chromed frame, 2x17 l bucket (red, blue), plastic press, grate, bucket for materials, holding frame, 70 l

Wet Mops and Bucket Systems – Mopping Carts



Roll press system Item No. 428810
15 l volume, removable divider, foot controlled roll press



2-chamber mopping cart
Item No. 459208
19 l, incl. press, with removable divider, ca. 7 l volume each chamber



Mopping cart "Maxi" with press

incl. press

Item No.	Item	Size
467970	yellow	25 l
467960	blue	25 l
467965	red	25 l
467975	green	25 l

Rectangular bucket with cover and rolls

Item No. 457706
22 l, blue, ca. 42x32x24 cm, with 4 removable rolls





AUXILIARY EQUIPMENT AND ACCESSORIES

Cloths, Sponges, Pads

Superpads

White, fawn, green, red, blue, black. More sizes on request.



Item No.	Item	Type	Size (ca.)
Superpad 41_Colour		White, fawn, green, red, blue, black	41 cm
Superpad 46_Colour		White, fawn, green, red, blue, black	46 cm
Superpad 51_Colour		White, fawn, green, red, blue, black	51 cm
468983	melamine pad for special cleaning		

Shoe pad with elastic band



Item No.	Item
462610	white
462620	green
462625	black
462626	red

Hand pads and mount



Item No.	Item	Size (ca.)
462500	hand pad	16x23x1 cm
462600	super hand pads	12x25x2,5 cm
462700	hand block	10x23 cm
462800	stick block	10x23 cm
468984	dirt eraser hand pad	
462760	dirt eraser white melamine	

Microfibre towels

Lorito Bamboo: with 50% mikrofibre and 50% bamboo fibre.

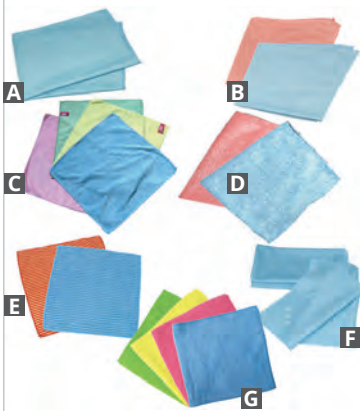

Item No.	Item	Type	Size (ca.)
A 453700	Loritex	pink, blue, yellow, green	40x40 cm
B 453702	window towel ripped	blue, red	40x40 cm
C 453709	KOI	red, blue, yellow, green	40x40 cm
D 453710	Loritex Light	blue	40x40 cm
D 453711	Loritex Light	red	40x40 cm
E 453718	Lorito Bamboo	red	40x40 cm
E 453719	Lorito Bamboo	blue	40x40 cm
F 453730	Xtrafine	blue	40x40 cm
F 453727	Xtrafine	red	40x40 cm
F 453729	Xtrafine Maxi	blue	50x70 cm
F 453730	Xtrafine Maxi	red	50x70 cm
G 453714	Flauschi	blue, red, green, yellow	40x40 cm

Cloths

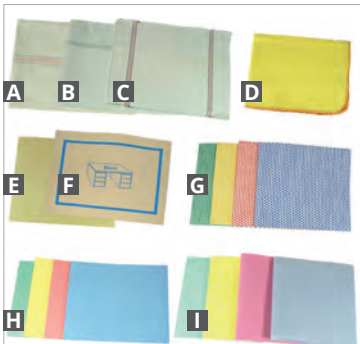

Item No.	Item	Type	Size (ca.)
A 651300	floor cloth, extra strong	cotton	50x70 cm
B 651400	fleece pick-up	synthetic	50x70 cm
C 651500	waffle wipe	cotton	35x35 cm
D 651600	duster	yellow	40x50 cm
651702	cleansing wipe, unperforated	red, blue, yellow, green	35x40 cm
E 651711	professional cleansing wipe, perforated	super quality	35x40 cm
F 651712	professional cleansing wipe, perforated	super quality with pictogram	35x40 cm
G 652400	general-purpose cloth	red, blue, yellow, green	30x40 cm
H 653400	sponge cloth	red, blue, yellow, green	25x31 cm
I 653900	general-purpose fleaze cloth	yellow, pink, blue, green	38x40 cm

Sponges



Item No.	Item	Type	Size (ca.)
415900	blackboard eraser		15,5x11x6 cm
462300	sponge pad with recessed grip	yellow-green	15x8 cm
462400	sponge pad with recessed grip	blue-white	13x7 cm
462410	sponge pad with recessed grip	red-white	13x7 cm
462420	sponge pad with recessed grip	yellow-white	13x7 cm
462421	sponge pad with recessed grip	green-white	13x7 cm
422222	spiral scouring pad, 60 g		
462760	sponge eraser		

Plastic Buckets & Bags



Disinfection trough

Item No.	Item	Size
463641	plastic, blue	35 l
464641	plastic, blue	45 l



Plastic buckets, round

Item No.	Item	Size
652900	bucket, blue, red	5 l
652800	bucket, blue, red	10 l
411200	massive bucket, black	12 l



Plastic buckets, rectangular

Item No.	Item	Size
A 457810	red, blue, yellow, green	4 l
459400	red, blue, yellow, green	6 l
459300	red, blue, yellow, green	12 l
B 460000	with bucket spout, 27x27x28 cm, blue, red	17 l
C 459700	with bucket spout, 30x30x35 cm, blue, red	25 l
457700	40x20x20 cm, red - for window cleaning	12 l
457702	with plastic sieve and rolls, yellow	22 l
460001	red, blue with bucket spout	17 l
457701	rectangular bucket, blue	22 l
422700	rolls for item 457701	
422500	bucket grid for item 457701	



Plastic bags / bin liner

Bin liner and plastic bags in different material thicknesses, colours and sizes available.

Item No.	Item	Size
459095	paper back, brown with imprint "Abfall" (waste)	120 l
512100	HDPE bin liner transparent, 100 piece roll, ca. 450x520 mm	16 l
528501	bin liner grey, 30 piece roll	30 l
564074	Linothene blue, extra strong, 25 piece roll, ca. 700x1100 mm	120 l
565300	LDPE-bin liner blue, 25 piece roll, 700+200x1100 mm	140 l
565500	LDPE-bin liner BRILLANT A, black, 25 piece roll, ca. 700x1100 mm	120 l
565501	LDPE-bin liner BRILLANT B, light blue, 25 piece roll, ca. 700x1100 mm	120 l
565510	bin liner Type 100, dark blue, 15 piece roll	120 l
565600	LDPE-bin liner Type 60, light blue, 25 piece roll, ca. 575x1000 mm	70 l
565700	HDPE-bin liner eco, transparent, 50 piece roll, ca. 700x1100mm	120 l
565900	HDPE-bin liner transparent, 50 piece roll, ca. 500x600 mm	30 l
569855	HDPE-bin liner hostess, white, 40 piece roll, ca. 630x850 mm	60 l



Roll press system, yellow

Item No. 428810
15 l, 2 chambers

Brushes & Brooms



Brooms and scrubbers 4-hole patented system

Item No.	Item	Size
A 650000	nylon broom, wooden frame	30 cm
B 650200	street broom, elastane	60 cm
650250	street broom, elastane	40 cm
C 650300	coconut fibre broom	40 cm
650400	coconut fibre broom	60 cm
650401	coconut fibre broom	80 cm
D 650500	house broom, mixture hair	30 cm
E 650600	industrial broom, mixture hair	40 cm
650700	industrial broom, mixture hair	60 cm
650701	industrial broom, mixture hair	80 cm



Brooms 1-hole system

Item No.	Item	Size
A 248200	professional street broom, elastane with wooden stick (140cm)	40 cm
248600	professional street broom, elastane with wooden stick (140cm)	60 cm
B 660500	industrial broom, high-quality material with metal stick holder	80 cm
C 660800	industrial broom, coconut fibre with metal stick holder	80 cm

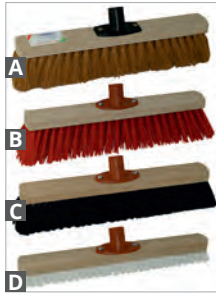

Brooms and scrubbers 1-hole-system with powerstick mount

Item No.	Item	Size
A 231093	industrial broom, coconut fibre	40 cm
231493	industrial broom, coconut fibre	60 cm
B 234093	industrial broom, elastane	40 cm
234393	industrial broom, elastane	60 cm
C 238393	industrial broom, mixture hair	40 cm
238693	industrial broom, mixture hair	60 cm
D 320593	PPN wipe	30 cm
320993	PPN wipe	40 cm



Tool handles

Item No.	Item	Size
413600	glass fibre stick	1,40 m
457920	aluminium stick, blue	1,40 m
457910	telescopic stick, aluminium	1,50 m
452300	wooden stick, unpainted	1,40 m

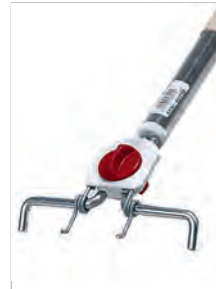

Tool handles 4-hole patented system

Item No.	Item	Size
650800	aluminium stick, patented	1,50 m
650801	wooden stick, patented	1,50 m

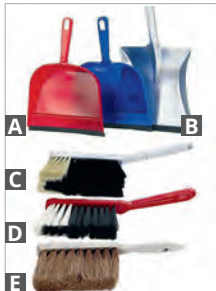

Dustpans and brushes

Item No.	Item
A 650900	plastic pan with rubber lip
B 651000	sheet pan with rubber lip
C 651100	hand broom, hair mixture
E 651200	hand broom, coconut fibre
D 651201	hand broom, nylon, plastic body, food-safe

Brushes & Brooms



Dustpan and broom Item No. 650901
blue with rubber lip, snap-on broom



Stand-up dust-pan with broom
Item No. 459280
grey, deluxe



Sanitary brushes

Item No.	Item	Size
A 650001	nylon, plastic body, 4-hole patented system	30 cm
650101	nylon, plastic body, 4-hole patented system	40 cm
B 650352	general purpose brush, plastic, white, 8-shaped	
C 650353	general purpose brush, PP, pointed-round	18 cm
D 651201	hand broom, nylon, plastic body	



Floor and ceiling brush

Item No.	Item	Size
653600	extendible, oval	1,50 m
459290	mountable on telescopic handle	



Heater brush Item No. 652700
U-shaped, length: 35 cm



Feather duster

Item No.	Item	Size
A 456204	telescopic feather duster lambskin	70-110 cm
B 456207	duster stick with microfibre cover	90 cm
456206	microfibre cover replacement	50x10 cm

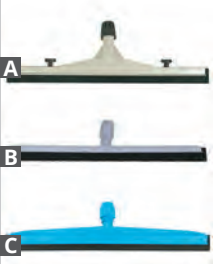

Water pusher
plastic, with foam rubber

Item No.	Item	Size
A 401049	foam rubber exchangeable , grey	45 cm
A 401050	foam rubber exchangeable , grey	55 cm
A 401047	foam rubber exchangeable , grey	75 cm
B 659500	"extra strong", grey	35 cm
B 659501	"extra strong", blue	35 cm
C 659700	"extra strong", blue	45 cm
C 659800	"extra strong", blue	55 cm
C 659900	"extra strong", blue	75 cm

Accessories

401048	replacement for foam rubber pusher, 45 cm
401051	replacement for foam rubber pusher, 55 cm
401054	replacement for foam rubber pusher, 75 cm

Other Equipment

Gloves		
Item No.	Item	Size
B 651801	neoprene, chemical-resistant, CE-certified, pair	L, XL
A 653000	rubber, food-safe, yellow, pair	S, M, L, XL
C 653020	disposable gloves, vinyl, transparent, powdered, 100 Stk.	M, L
D 653040	disposable gloves, nitrile, blue, powder-free, 100 Stk.	M
653041	disposable gloves, nitrile, blue, powder-free, 100 Stk.	L
E 620004	microfibre gloves, neon-green	uni

Latex gloves		
blue rubber glove, 1-A quality, natural latex, food-safe, cotton flocked inside, tearproof, with a secure grip, 40 boxes/palette		
Item No.	Item	Size
653006	box with 144 pcs.	M
653007	box with 144 pcs.	L
653008	box with 144 pcs.	S

Fork mop		Item No. 653700
synthetic, 45 cm		

Danger signs		
Item No.	Item	Size
463700	with label "Achtung Rutschgefahr" (Attention wet floor), threepart	ca. 97cm
463701	with label "Achtung Rutschgefahr" (Attention wet floor), twopart	ca. 57cm
463703	neutral, twopart, with symbol	ca. 57cm
463704	neutral, threepart, with symbol	ca. 97cm
463706	neutral, twopart	ca. 57cm
463707	neutral, threepart	ca. 97cm

Spray can		
1,5 l, various spray attachments for different bottles available		
Item No.	Item	Size
565101	with force pump	1,5 l
565103	for acid cleaners	1,5 l
565104	for alcalic cleaners	1,5 l

Doormats		
Polyester fibre with rubber back, in colours black-white, black-red oder black-blue		
Item No.	Item	Size
465700	mat	40x60 cm
465750	mat	60x90 cm
465800	mat	90x150 cm
465802	roll, black-white	1,20x20 m
465900	mat	120x180 cm

Metal scraper		Item No. 651800
extra strong, width: 5 cm		

Waste picker		Item No. 402160
Waster/paper picker to pick up from the floor		

A close-up photograph of a person's hand holding a white, textured paper napkin. The hand is positioned at the bottom left, with fingers gently gripping the edge of the napkin. The napkin is held up, showing its intricate, embossed pattern. The background consists of white, vertically-oriented rectangular tiles with dark grout. The lighting is soft and even, highlighting the texture of the paper and the skin of the hand. A solid pink horizontal bar is overlaid at the bottom of the image, containing the text.

SANITARY EQUIPMENT AND ACCESSORIES

Hygienic Paper & Dispensers



Paper towel dispenser
 Item No. 654100
 metal with lock, 27x33x13 cm



Paper towel dispenser Lorito
 Item No. 654147
 plastic for C/VL-fold, 27,5x28x13 cm



Jumbo paper roll mount
 Item No. 633460
 white, metal with hex-wrench



Hygienic pouches and dispenser

Item No.	Item
654400	hygienic pouches, eco-paper, 28x12x5 cm
654410	hygienic pouch dispenser



Hygienic paper

Item No.	Item	Type	Size
633520	jumbo paper	two-ply, on roll	360 m
653512	toilet paper Lorito Soft	two-ply, 250 sheets	
653511	toilet paper Lorito Flauschi	three-ply, 250 sheets	
653540	toilet paper frisch+sauber	recycled, 2-lagig, 250 sheets	
654130	paper towel	natural, quire fold, single ply, 3640 sheets	25x33 cm
654140	cleansing tissue	two-ply, 100 pcs. per box	
654200	paper towel Lorito	natural, ZZ/V fold, single ply	25x21 cm
654213	paper towel Lorito	natural, ZZ/V, cellulose, 1A, two-ply	25x21 cm
10369020	kitchen roll	two-ply, 4x51 sheets	



Urinal Deodorizer

Item No.	Item
652605	Tutti-Frutti
652606	Apple
652607	Mango
652614	Ocean



Air Freshener Dispenser

Item No.	Item
652608	Apple
652609	Tutti-Frutti
652611	Mango
652615	Ocean



Papier bin Item No. 654300
 white, foldable, sintered, 40x23x64 cm



Air Freshener Curve
 with holder

Item No.	Item
652625	Citrus
652623	Cotton Blossom
652624	Fabulous
652622	Herbal Mint
652621	Mango

Soap Dispensers



Soap dispenser
plastic

Item No.	Size
626720	1000 ml
626770	500 ml



Foam soap dispenser
cylindric, 250 ml, 18x6,5 cm, in different colours

Item No.	Item
626000	white
626001	black
626002	red
626003	bramble
626004	aqua



Soap dispenser Item No. 627000
with special steel force pump and cover, lockable, 1000 ml



Soap dispenser Lorito
Item No. 626820
plastic, without cover, for cream soap, refillable, lockable, 1000 ml



Foam dispenser Lorito
Item No. 626705
special steel/plastic parts and pump, 500 ml

Accessories	
126706	"Lori Foam" foam soap, 5 l



Foam soap dispenser with foaming unit Item No. 625000
plastic, 550 ml



Cartridges for soap dispenser

Item No.	Item	Size
326800	soap dispenser cartridge for CWS	500 ml
326802	soap dispenser cartridge for Apura	750 ml
326803	soap dispenser cartridge for Tork and Mölntyke (old)	1000 ml
326804	soap dispenser cartridge for CWS	400 ml
326900	soap dispenser cartridge for CWS	950 ml



Rioloto peach soap Item No. 430700
in pump dispenser, 500 ml

Other Accessories

**Toilet brush****Item No. Item**

650358	urinal brush
652500	toilet set
652515	toilet brush, plastic

**Waste bin**

chromed with plastic inlay

Item No. Item

60011	Treteimer 13 Liter
60021	Treteimer 3 Liter

**Pumie scouring stick**

performs, where chemicals are useless!

Item No. Item

652516	Pumie Stick with handle
652517	Pumie Stick

**Funnel tube 150 cm**

Item No. 464211

suitable for almost all water-tap, put plastic nozzle over the tap ... and ready!

**HERWE Cura Skin care creme**

Item No. 10191

White, mild greasing and quickly absorbed creme with bees wax, without silicones. Tube, 100 m

**Socket cleaning brush****Item No. Item**

650362	socket cleaning brush
650363	socket cleaning brush "combi"

**Fugenal Fuginator joint brush**

Item No. 650364

Fuginator cleans all mineral elastic joint seal and removes dirt easily from any joint. Ergonomic grip, effective working.

**Waste-paper baskets**

Item No. 61069

18 l

A cleaning trolley is shown in a room with a blue carpet and a window. The trolley has a grey frame and four wheels. A large yellow fabric cover is draped over the main body of the trolley. On top of the trolley, there is a blue bucket with a blue cloth on top. To the left of the trolley, there is a colorful feather duster with blue, green, and yellow sections. A pink cleaning tool is also visible on the side of the trolley. The background shows a window with a view of a red building outside.

CLEANING & HOTEL TROLLEYS

Cleaning & Hotel Trolleys

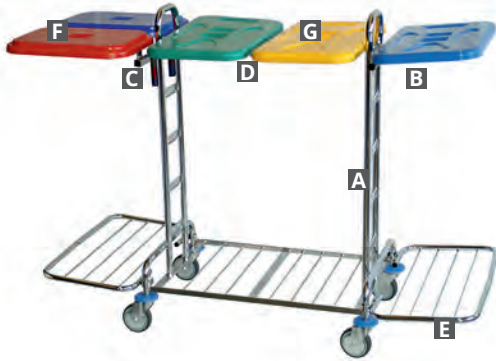

Serie 105 waste trolley Item No. 46105

holding frame: 1x120 l, 2x120 l, 2x70 l & for one trough; grate shelf, plastic cover 70 l, clip for plastic bag.

Accessories

- A 46200 base frame incl. 2 equipment frames, 52x82 cm
- B 46205 holding frame sideways, 1x120 l
- 46206 holding frame sideways, strengthened, 2x120 l
- D 46207 holding frame, centred, 2x120 l
- C 46208 holding frame sideways, 2x70 l
- E 46209 grate shelf
- 46216 gabion cage, lockable
- F 46221 plastic cover, 70 l
- G 46222 plastic cover (red, blue, green, yellow), 120 l
- 464210 stick holder with snap fit, Ø 22 mm
- 464212 broom holder with snap fit, Ø 22 mm
- 464215 stick holder, adjustable clip-flip
- 464606 grate shelf with roll
- 468260 mounting clip for plastic bags



Serie 106 Item No. 46106

base frame, equipment frame, rack for bucket, holding frame 120 l sideways and for trough, grate shelf, trough small and holding frame (central), clips for plastic bag, plastic press, plastic bucket 17 l in red, blue.

Accessories

- A 46200 base frame incl. 2 equipment frames, 52x82 cm
- 46204 rack for 2x17 l buckets
- B 46205 holding frame sideways, 1x120 l
- 46206 holding frame sideways, strengthened, 2x120 l
- 46208 holding frame sideways, 2x70 l
- C 46209 grate shelf
- D 46211 plastic trough small, 45x26x8 cm
- 46216 gabion cage, lockable
- 46218 holding frame for plastic trough small
- 46221 plastic cover, 70 l
- 46222 plastic cover (red, blue, green, yellow), 120 l
- E 460000 plastic bucket, rectangular, (red, blue), 17 l
- 463642 bucket grid (sieve)
- 464210 stick holder with snap fit, Ø 22 mm
- 464212 broom holder with snap fit, Ø 22 mm
- 464215 stick holder, adjustable clip-flip
- 464503 mount for toilet paper rolls
- 464606 grate shelf with roll
- 468260 clip to mount the plastic bags
- F 468400 plastic press



Serie 107 Item No. 46107

base frame, equipment frame, gabion cage, press mount, holding frame 120 l sideways for trough, grate shelf, clips for plastic bag, plastic press, plastic bucket 6 l in red, blue, yellow, plastic bucket 17 l in red, blue.

Accessories

- A 46200 base frame incl. 2 equipment frames, 52x82 cm
- B 46202 gabion cage, 62x23x13 cm
- C 46203 press mount
- D 46205 holding frame sideways, 1x120 l
- 46206 holding frame sideways, strengthened, 2x120 l
- 46208 holding frame sideways, 2x70 l
- E 46209 grate shelf
- 46216 gabion cage, lockable
- 46221 plastic cover, 2x70 l
- 46222 plastic cover (red, blue, green, yellow), 120 l
- F 459400 plastic bucket, rectangular, (red, blue, yellow, green), 6 l
- G 460000 plastic bucket, rectangular, 17 l
- 464210 stick holder with snap fit, Ø 22 mm
- 464212 broom holder with snap fit, Ø 22 mm
- 464215 stick holder, adjustable clip-flip
- 464503 mount for toilet paper rolls
- 464606 grate shelf with roll
- 468260 clip to mount the plastic bags
- H 468400 plastic press

Cleaning & Hotel Trolleys



Serie 108 Item No. 46108

base frame, equipment frame, holding frame 1x120 l, sideways u. holding frame for trough, grate shelf, holding frame and plastic trough large, bucket holder 2x6 l, disinfectant trough and bucket grid, clips for plastic bag, plastic bucket 6 l in red, blue, yellow, green.

Accessories

- A 46200 base frame incl. 2 equipment frame, 52x82 cm
- B 46202 gabion cage, 62x23x13 cm
- C 46205 holding frame sideways, 1x120 l
- 46206 holding frame sideways, strengthened, 2x120 l
- 46208 holding frame sideways, 2x70 l
- D 46209 grate shelf
- 46212 holding frame for plastic trough large
- 46216 gabion cage, lockable
- 46220 bucket holder, 2x6 l
- 46221 plastic cover, 2x70 l
- 46222 plastic cover (red, blue, green, yellow), 120 l
- E 459400 plastic bucket, rectangular, (red, blue, yellow, green), 6 l
- 463642 bucket grid (sieve)
- 464210 stick holder with snap fit, Ø 22 mm
- 464212 broom holder with snap fit, Ø 22 mm
- 464215 stick holder, adjustable clip-flip
- 464503 mount for toilet paper rolls
- 464606 grate shelf with roll
- F 464641 disinfectant trough, 45 l
- G 468250 plastic trough big, 60x48x8cm
- 468260 clip to mount the plastic bags



Serie 203 Item No. 450203

base frame, 2 rolls 180 mm and rack for clip holder, equipment frame, plastic trough and holding frame, grate shelf, holding frame for plastic bag 120 l, bottle rack, stick holder, adjustable clip-flip, clip for plastic bag, plastic press, plastic bucket 6 l in red, blue, plastic bucket 17 l in red.

Accessories

- A 46211 plastic trough, 47x26x8 cm
- B 451200 base frame Serie 203 (incl. 2 rolls 100 mm, 2 rolls 180 mm and rack for clip mount, rectangular bucket, red, blue, 6 l)
- C 451201 equipment frame, height: 98 cm
- D 451202 grate shelf
- E 451203 holding frame for plastic bag (short mount), 120 l
- 451204 holding frame for trough (long mount)
- 451205 bottle rack
- 451206 holding frame 2x70 l
- 451207 holding frame 2x120 l
- F 459400 plastic bucket, rectangular, (red, blue, yellow, green), 6 l
- G 460000 plastic bucket, rectangular, (red, blue), 17 l
- H 464215 stick holder, adjustable clip-flip
- 468260 clip for plastic bag
- I 468400 plastic press



Serie 204 Item No. 450204

base frame Serie 204, equipment frame, press mount, plastic trough u. holding frame, holding frame for plastic bag 120 l, bottle rack, stick holder adjustable clip-flip, clip for plastic bag, plastic press, plastic bucket 6 l in red, blue, plastic bucket 17 l in red, blue.

Accessories

- A 46211 plastic trough, 47x26x8cm
- B 451203 holding frame for plastic bag (short mount), 120 l
- 451204 holding frame for trough (long mount)
- 451205 bottle rack
- 451206 holding frame 2x70 l
- 451207 holding frame 2x120 l
- C 451208 base frame Serie 204, incl. 4 rolls 100 mm
- D 451209 equipment frame, height: 96 cm
- 451210 press mount
- E 459400 plastic bucket, rectangular, (red, blue), 6 l
- F 460000 plastic bucket, rectangular, (red, blue), 17 l
- G 464215 stick holder, adjustable clip-flip
- 468260 clip for plastic bag
- H 468400 plastic press

Cleaning & Hotel Trolleys



System trolley "Willy" Item No. 459248

multifunctional, highly customisable plastic system trolley for the cleaning and housekeeping sector.

Accessories

OE 4010201	base plate large
OE 4010202	cover plate large
OE 4010203	base plate small
OE 4010204	cover plate small
OE 4010205	mounting frames
OE 4010206	sack holding frame, 120 l
OE 4010207	mount for sack holding frame
OE 4010208	cover for 120 l holding frame (red, blue, yellow, green)
OE 4010209	plastic bucket, rectangular (handle red, blue, yellow, green), 8 l
OE 4010211	sack holding frame (red, blue), 60 & 120 l
OE 4010212	plastic trough for mop rack
OE 4010213	extension for sack holding frame to 2x70 l
OE 4010214	rail for plastic trough
OE 4010215	mop rack
OE 4010216	stick holder
OE 4010220	hook for equipment
OE 4010222	clip holder for hook/stick holder
OE 4010223	plug holder for hook/stick holder
OE 4010225	plastic press
OE 4010227	handle
OE 4010237	side panel
OE 4010234	door lock
OE 4010238	door left/right
OE 4010241	storage container, rectangular (grey), 20 l
OE 4020003	press mount
OE 4020001	roll 100 mm, without brake
OE 4020002	roll 100 mm, with brake
OE 4020005	roll 150 mm, without brake
OE 4020006	roll 150 mm, with brake
OE 4000007	plastic bucket, rectangular (red, blue), 20 l
OE 4072005k	laundry bag, 120 l, red



Cleaning trolley "Max" Item No. 48201

high-quality, coated with Rilsan® (high-performance polymere produced from natural raw material). Equipped with 2 mounting frames, plastic buckets 12 l in red, blue, plastic buckets 17 l in red, blue, press mount, plastic press, adjustable stick holder, sack holding frame, grate shelf, 2 plastic troughs (grey)

Accessories

A	482000	base frame, 53x85cm
B	4860000	plastic bucket, rectangular, red, blue, 17 l
C	459300	plastic bucket, rectangular, red, blue, 12 l
D	482006	press mount
E	468400	plastic press
	464215	stick holder, adjustable
	466010	sack holding frame, 120 l
F	482001	mounting frame
G	482003	grate shelf, plastic
H	482005	plastic trough



Hotel trolley Item No. 459246

plastic, with door, measures (hxxwx): 130x160x57 cm

4 grey rubber rolls Ø 20 cm, thereof two flexible with brakes, 2 fabric-reinforced laundry bags 85 l with zip, 3 shelves 77x46 cm, 1 upper storage rack 77x47 cm, several mounts for equipment, edge protection (4 flexible rolls).



Housekeeping trolley "Thommy", "Thommy Duo"

holding frame with integrated storage rack, cover, handles, hooks. Multifunctional mounts for equipment. With shelf, fabric-reinforced laundry bag (65 l) with zip, grey rubber rolls, thereof two flexible rolls.

Item No. Item

- 459275 Thommy, 70 l
- 459276 Thommy Duo, 2x70 l
- 459277 Thommy 2x25l with press

Accessories

- 401001 plastic bucket combi, red, 6 l
- 401002 plastic bucket combi, yellow, 6 l
- 401003 plastic bucket combi, blue, 6 l
- 401004 plastic bucket combi, green, 6 l
- 401005 plastic bucket combi, blue, 25 l
- 401006 plastic bucket combi, red, 25 l
- 457810 bucket (red, yellow, blue, green), 4 l
- 460000 plastic bucket, red, blue, 17 l



Housekeeping trolley "Elegance" Item No. 469000

high-quality, coated with Rilsan® (high-performance polymere produced from natural raw material). This trolley is used in many 5-star hotels!

Measures (LxWxH): 178x56x127 cm, with storage rack: 178x56x142 cm

With plastic storage rack, 2 grey fabric-reinforced laundry bags (120 l), 1 door stopper, 8 edge protection discs

Cleaning & Hotel Trolleys



Waste trolley x-formed

with Ø 100 mm rolls.

Item No. Item

464500	chromed holding frame without mounts
464501	complete with 1x120 l chromed holding frame
464502	complete with 2x120 l chromed holding frame
463800	galvanised holding frame without mounts
463801	complete with 1x120 l galvanised frame
463802	complete with 2x120 l galvanised frame

Accessories

462200	galvanised storage grate, sideways
462900	galvanised holding frame sideways, 1x120 l
462901	cover for holding frame 1x120 l, centered
463500	galvanised holding frame tandem, centered, 2x120 l
464000	box sack polypropylene, with loops, 140 l, 48x48x88 cm
464200	stick holder for one stick, plastic
464310	panel with pocket, 3-rowed, 10 pockets
464600	chromed holding frame for 1x120 l plastic bag
457700	rectangular bucket, plastic, red, 12 l
468100	metal basket, plastic-coated, 42x21x21 cm



Laundry trolley „Steve“

Item No. 459320

measures: 90 x 66 x 86 cm, laundry bag, ca. 220 l

Accessories

459321	laundry bag, ca. 220 l
--------	------------------------

A woman in a black and white maid uniform is using a grey upright vacuum cleaner on a red carpet in a hallway. The vacuum cleaner is a canister-style upright, and the woman is holding the handle. The hallway has white walls, a red carpet, and a window at the end. A purple banner with white text is overlaid at the bottom of the image.

VACUUM CLEANERS

Vacuum Cleaners



Lorito Silent 10 / 15

Power:	1200 W	Hose length:	2,5 m
Air flow:	35 l/sec	Weight:	7 kg / 8 kg
Tank capacity:	10 l / 15 l	Sound level:	59 dB
Cable length:	10 m		



Webcode: #pef8

Equipment

flexible hose with intake manifold and false air regulator, combination floor tool, crevice nozzle, radiator brush, two-parted stainless steel tube, 1 paper filter.

Item No. Item

491000	Silent 10
491510	Silent 15

Accessories

481029	aluminium telescopic tube
--------	---------------------------



Lorito Profi Item No. 443500

Power:	1200 W	Hose length:	2,5 m
Container capacity:	10 l	Weight:	6,3 kg
Water level:	2700 mm	Sound level:	ca. 64 dB
Cable length:	15 m		



Webcode: #kp7y

Equipment

flexible hose with intake manifold and false air regulator, combination floor tool, crevice nozzle, radiator brush

Accessories

481029	aluminium telescopic tube
--------	---------------------------



Hitachi CV-300, CV-300 P

single-level turbo compressor, safety automatic

Power:	1300 W	Hose length:	3 m
Container capacity:	7,5 l	Weight:	4,5 kg
Cable length:	12 m	Sound level:	63 dB



Webcode: #igtY

Equipment

hardened vinyl tube with bented extension, 3 extension tubes, combination floor tool, crevice nozzle, all-purpose brush, HEPA-filter.

Item No. Item

448103	CV-300
448104	CV-300 P

Type

with fabric filter
with 2 paper filter at 4,5 l



Hitachi CV-400 Item No. 448105

well-ried for over 40 years, robust plastic case, energy-saving engine. Available colours: blue, green, orange, pink.

Power:	900 W	Hose length:	3 m
Tank capacity:	7,5 l	Weight:	4 kg
Cable length:	10 m	Sound level:	73 dB



Webcode: #wt1h

Equipment

hardened vinyl tube with bented extension, 3 metal extension tubes, combination floor tool, crevice nozzle, all-purpose brush.

Vacuum Cleaners

**Hitachi CV-940** Item No. 449000

turbine with 33.500 turns/min, blow gun

Power:	1600 W	Hose length:	2 m
Tank capacity:	18 l	Weight:	6,2 kg
Cable length:	12 m	Sound level:	64 dB



Webcode: #ghvz

Equipment

hardened vinyl tube with bented extension, 2 metal extension tubes, combination floor tool, crevice nozzle, all-purpose brush.

**Lorito Baby** Item No. 491520

Power:	1200 W	Weight:	7 kg
Tank capacity:	7 l	Sound level:	55 dB
Cable length:	10 m		



Webcode: #6g4d

**Cleanfix S10 Plus** Item No. 022010

vacuum 250 mbar, 5 rolls, measures (LxWxH): 40x40x49 cm

Power:	1100 W	Weight:	7 kg
Tank capacity:	9 l	Sound level:	62 dB
Bag capacity:	6 l	Cable length:	10 m



Webcode: #2uqa

Hint

**Save expenses!**

We operate repairs and safety-related checks in our electro-workshop for your single-disc-machines, Cleanfix-machines, Duplex-carpet-cleaning-machines, spray-extraction-machines, power-sweeper, dry and wet cleaners as well as industry cleaners according to DIN DIN VDE 0701 / 0702!

If you have any question, please contact us under:

Tel.: +49 (0) 9176 / 9805-0

E-Mail: info@oehme-lorito.de

Wet and Dry Cleaners

**Lorito SW 38** Item No. 448031

Power: 1000 W
 Tank capacity: 38 l
 Water capacity: 23 l
 Water level: 2000 mm

Cable length: 10 m
 Hose length: 2,6 m
 Weight: 13 kg



Webcode: #7ual

Equipment

suction hose 2,60 m, metal tube two-parted, combination floor tool, crevice nozzle, all-purpose brush, vacumat nozzle.

Accessories

BF866 fleece filter bag

**SW 93** Item No. 448071

two-level motor, diameter for accessories: 38 mm

Power: 2x1000 W
 Tank capacity: 73 l
 Water level: 2000 mm

Cable length: 10 m
 Hose length: 2,6 m
 Weight: 27 kg (complete)



Webcode: #6j7q

Equipment

suction hose, 2,60 m, metal tube two-parted, combination floor tool, crevice nozzle, all-purpose brush, vacumat nozzle.

**SW 30 Cleanair** Item No. 446710

with by-pass cooling

Power: 1000 W
 Tank capacity: 30 l
 Water level: 2200 mm

Cable length: 10 m
 Hose length: 2,7 m
 Weight: 10 kg



Webcode: #2rp7

Equipment

hardened suction hose, extension tubes, combination floor tool, vacumat nozzle, suction tube, radiator brush.

**SW 55 Cleanair** Item No. 446850

with by-pass cooling

Power: 1000 W
 Tank capacity: 55 l
 Water level: 2200 mm

Cable length: 10 m
 Hose length: 2,7 m
 Weight: 22 kg



Webcode: #hmuw

Equipment

hardened suction hose, extension tubes, combination floor tool, vacumat nozzle, crevice nozzle, radiator brush.

Accessories

447800 suction cart 65 cm, with hose
 447801 suction cart 75 cm, with hose

Wet and Dry Cleaners

**SW 75 Cleanair** Item No. 447210

with by-pass cooling

Power:	3x1000 W	Cable length:	10 m
Tank capacity:	75 l	Hose length:	2,7 m
Water level:	2600 mm	Weight:	31 kg



Webcode: #hwwa

Equipment

hardened suction hose, extension tubes, combination floor tool, vacumat nozzle, crevice nozzle, radiator brush.

Accessories

447600	suction for rough dirt
447800	suction cart 65 cm with hose
447801	suction cart 75 cm with hose

**BF 584 A-3 with suction cart** Item No. 448090

diameter for accessories: 40 mm

Power:	3x1000 W	Hose length:	2,6 m
Tank capacity:	105 l	Working width:	65 cm
Water capacity:	75 l	LxWxH:	44x44x95 cm
Water level:	3000 mm	Weight:	30 kg
Cable length:	7,2 m		



Webcode: #b45v

Equipment

suction cart, working width 65 cm, suction hose 2,6 m, chromed metal tube two-parted, combination floor tool, vacumat nozzle, crevice nozzle, all-purpose brush.

Upright Vacuum Cleaners



SEBO 36 Comfort Item No. 900370

Power vacuum motor:	1300 W	Cable length:	12 m
Power Brush motor:	175 W	Hose length:	0,25 m (Stretch)
Tank volume:	5 l	Working width:	36 cm
Water level:	2350 mm	Weight:	7,9 kg

Equipment

telescopic hose with suction lance



Webcode: #541t



SEBO 46 Comfort Item No. 900470

Power Vacuum motor:	1300 W	Cable length:	12 m
Power Brush motor:	200 W	Hose length:	0,25 m (Stretch)
Tank volume:	5 l	Working width:	46 cm
Water level:	2350 mm	Weight:	8,5 kg

Equipment

telescopic hose with suction lance



Webcode: #3v6y



Ruck Zuck knapsack exhauster Item No. 446010

Power:	1350 W	Hose length:	1,1 m
Tank volume:	3,5 l	Weight:	4,8 kg
Cable length:	15 m		

Equipment

suction hose with bent and false air regulator, telescopic tube, extension tube, combination floor tool, crevice nozzle, all-purpose brush, radiator brush, 1 paper filter.



Webcode: #em6x

Accessories for Vacuum Cleaners

Combination floor tool

Item No. 929294

black, adjustable, working width: 290 mm, tube diameter: 35 mm

Combination floor tool

Item No. 914800

black, adjustable, working width: 270 mm, tube diameter: 32 - 37 mm adjustable

Combination floor tools

grey, adjustable, working width: 300 mm

Item No. Item

B 7790915	diameter, suitable for Hitachi
A 929293	Hitachi, diameter: 32 mm

Turbo nozzle Item No. 914700

black, adjustable, working width: 250 mm, tube diameter: 32 mm

Combination floor tool for parquet

working width 300 mm, tube diameter: 32 mm

Item No. Item

A 929299	hair mixture
B 929300	PP brush strips

Adapter for Hitachi nozzle

for vacuum cleaners with different tube diameters

Item No. Item

B 7790923	diameter: 35 mm
A 7790924	diameter: 32 mm

Crevice nozzle Item No. 700035

black, diameter suitable for Hitachi

All-purpose brush Item No. 700098

fixed, black, suitable for Hitachi

Hose set complete

Item No. 777777

fixed, black, suitable for Hitachi

Accessories Vacuum Cleaners

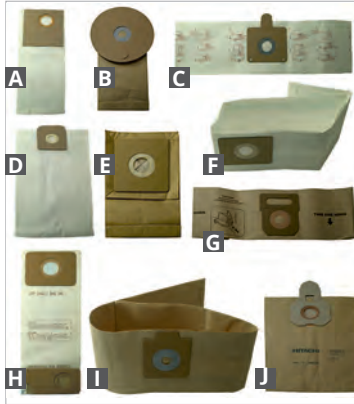

Paper filters

Item No.	Item
A 443301	for Lorito BS37/47
B 443315	for knapsack exhauster Free Vac 2,5
C 446505	for Lorito S11 old/new, Compacto 6, Compacto 9
D 480001	for vacuum cleaner OTTO 1210
E 490030	for vacuum cleaner OTTO 821
F 491010	for Lorito Silent 10
F 491015	for Lorito Silent 15
G 643533	for Lorito Profi
H 900000	combi, 2-layered for all BS and SEBO
I 920000	for GS 20 de Luxe
J 7318202	for Hitachi CV 200P/CV 300P
447021	for Rabbit Blue



Power cable

unpluggable, 2-pin, red, with Schuko plug and rubber connector

Item No. Item

481053	15 m, red, angle plug
970005	15 m, red, straight plug



Tubes for vacuum cleaners

Item No.	Item	Size
A 481029	telescopic tube	56-94 cm
B 970034	telescopic tube, 32mm	50-80 cm
C 7790922	extension tube suitable for Hitachi	44 cm



CLEANING MACHINES

Single Disc Machines

**BF 521** Item No. 669414

Planetary gear

Power:	1200 W	Cable length:	12 m
Revolution:	154 min ⁻¹	Working width:	43 cm
Tank volume:	12 l	Weight:	36,8 kg (complete)

Equipment

Driving disk, shampooing brush, washing brush, lye tank

Accessories

668445	driving disk
668446	shampooing brush
668447	washing brush
668448	lye tank



Webcode: #tbke

**C 143 L10** Item No. 669420

Planetary gear

Power:	1000 W	Working width:	43 cm
Revolution:	154 min ⁻¹	Weight:	41 kg
Cable length:	12 m		

Accessories

617307	lye tank, 12 l
668446	shampooing brush
668447	washing brush
669402	driving disk



Webcode: #dz7b

**C 143 TSN two speed** Item No. 618502

Planetary gear

Power:	1000 W / 1300 W	Working width:	43 cm
Revolution:	154 min ⁻¹ / 308 min ⁻¹	LxWxH:	54,2x42,5x120 cm
Working pressure:	41,8 g/cm ²	Weight:	42,5 kg
Cable length:	15 m		

Equipment

Driving disk

Accessories

617307	lye tank, 12 l
668446	shampooing brush
668447	washing brush



Webcode: #r2gp

**C 150 U 13 (polishing machine)** Item No. 681505

Power:	1500 W	Working width:	50,5 cm
Revolution:	1500 min ⁻¹	Weight:	44 kg
Working pressure:	variable	Sound level:	56 dB
Cable length:	15 m		

Equipment

Driving disk

Accessories

00-256EL	electric spray tool with tank
----------	-------------------------------



Webcode: #fwal

Single Disc Machines

**C 150 L 16** Item No. 618211

Planetary gear

Power: 1600 W
 Revolution: 154 min⁻¹
 Cable length: 15 m

Working width: 50,5 cm
 Weight: 49 kg



Webcode: #kmus

Accessories

617307 lye tank, 12 l
 618202 driving disk
 618206 shampooing brush
 618203 washing brush, PPN 0,7mm
 618204 polishing brush Union Natur
 618205 tynex brush (grinding) grit 1,2mm

**HS 2000** Item No. 670010

Belt drive

Power: 1100 W
 Revolution: 2000 min⁻¹
 Cable length: 15 m

Working width: 51 cm
 Weight: 35 kg



Webcode: #df6u

Accessories

619400 suction, 1207 white/blue, unmounted

**Lympia 13** Item No. 617201

Planetary gear

Power: 500 W
 Revolution: 188 min⁻¹
 Cable length: 10 m

Working width: 33 cm
 Weight: 22 kg



Webcode: #mn8j

Accessories

617202 driving disk with foam rubber and pad holder
 617203 washing brush, PPN 0,7mm
 617204 polishing brush Union Nature
 617205 shampooing brush, PPN 0,3mm
 617206 tynex brush (grinding) grit 1,2mm
 617207 lye tank, 9 l

**BF 520** Item No. 669541

Planetary gear

Power: 750 W
 Revolution: 190 min⁻¹
 Tank volume: 8 l

Cable length: 12 m
 Working width: 33 cm
 Weight: 25 kg (complete)



Webcode: #1voa

Equipment

Lye tank, driving disk, shampooing brush, washing brush.

Spray Extraction Machines



Sabrina Item No. 438403

Power vacuum motor: 1000 W
 Power regulator: 2 levels
 Sewage tank volume: 14 l
 Cleaning solution volume: 14 l

Water level: 2200 mm
 Cable length: 10 m
 Working width: 27 cm
 Weight: 12 kg



Webcode: #9pea

Accessories

NS10ALL all-purpose tool



Sabrina maxi Item No. 438404

Power vacuum motor: 1200 W
 Power regulator: 3 levels
 Sewage tank volume: 30 l
 Cleaning solution volume: 30 l

Water level: 2300 mm
 Cable length: 10 m
 Working width: 30 cm
 Weight: 22 kg



Webcode: #7qiu

Accessories

NS10ALL all-purpose tool



Spray extraction machine Profi Item No. 438407

Power vacuum motor: 1200 W
 Pump power: 40 W
 Max. pressure: 29 PSI (1,99 bar)
 Fresh water volume: 9 l

Sewage tank volume: 7 l
 Cable length: 7 m
 Weight: 12,85 kg (complete)
 Sound volume: 65 dB



Webcode: #m6ls

Equipment

1 floore toole, 235 mm working width, 1 all-purpose tool, 90 mm working width

Scrubber Dryers

**Two-roll cleaning machine**

Power: 750 + 26 W
 Revolution: 650 min⁻¹
 Max. ground coverage: 550 m²/h
 Fresh water volume: 4 l

Sewage tank volume: 1,7 l
 Cable length: 10 m
 Weight: 25 kg

Item No. Item

980000 Working width: 34 cm
 970000 Working width: 44 cm



Webcode: #53v4

**RA 300 E** Item No. 668400

with 2 disc brushes

Voltage: 12 V DC
 Power vacuum motor: 300 W
 Power brush motor: 150 W
 Revolution: 240 min⁻¹
 Pressure: 17 kg

Fresh water volume: 12 l
 Sewage tank volume: 11 l
 Working width: 33 cm
 Accu capacity: 25 Ah
 Weight: 35 kg (with accu)



Webcode: #gg32

**RA 431 E** Item No. 436713

Voltage: 230 V AC
 Gear power: 1100 W
 Power vacuum motor: 750 W
 Revolution: 180 min⁻¹
 Pressure: 34 kg

Fresh water volume: 35 l
 Sewage tank volume: 40 l
 Working width: 43 cm
 Cable length: 20 m
 Weight: 62 kg (complete)



Webcode: #8e92

**RA 431 B** Item No. 436712

Voltage: 12 V DC
 Gear power: 750 W
 Power vacuum motor: 400 W
 Revolution: 135 min⁻¹
 Pressure: 54 kg

Fresh water volume: 32 l
 Sewage tank volume: 38 l
 Working width: 43 cm
 Weight: 122 kg (without accu)



Webcode: #fwgz

**RA 501 E** Item No. 501000

Voltage: 230 V AC
 Gear power: 1100 W
 Power vacuum motor: 750 W
 Revolution: 180 min⁻¹
 Pressure: 34 kg

Fresh water volume: 35 l
 Sewage tank volume: 40 l
 Working width: 50 cm
 Cable length: 20 m
 Weight: 62 kg (complete)



Webcode: #nx7x

**RA 501 B** Item No. 501010

Voltage: 12 V DC
 Gear power: 1000 W
 Power vacuum motor: 400 W
 Revolution: 135 min⁻¹
 Pressure: 48 kg

Fresh water volume: 32 l
 Sewage tank volume: 38 l
 Working width: 50 cm
 Cable length: 20 m
 Weight: 122 kg (without accu)



Webcode: #fp84

Scrubber Dryers



RA 605 IBCT Item No. 565055

Voltage: 24 V DC
 Gear power: 750 W
 Power vacuum motor: 400 W
 Revolution: 218 min⁻¹
 Pressure: 55 kg

Fresh water volume: 55 l
 Sewage tank volume: 56 l
 Working width: 62 cm
 Suction width: 88 cm
 Weight: 190 kg (without accu)



Webcode: #ig6k



Minispeed 350 E Item No. 636370

compact, foldable construction, easy transportation, fits in every trunk/boot. Automatic disc replacement. Multifunctional with different scrubbing and polishing discs. With 1 brush.

Voltage: 230 V AC
 Gear power: 750 W
 Power vacuum motor: 880 W
 Pressure: 25 kg
 Water level: 1950 mm

Fresh water volume: 13 l
 Sewage tank volume: 16 l
 Working width: 350 cm
 Suction width: 500 cm
 Weight: 38 kg (empty)



Webcode: #gmpi



Minispeed 350 B Item No. 636360

compact, foldable construction, easy transportation, fits in every trunk/boot. Automatic disc replacement. Multifunctional with different scrubbing and polishing discs. With 1 brush. Batteries: 2x 12V / 18 AH, 60 minutes battery life.

Voltage: 24 V DC
 Gear power: 200 W
 Power vacuum motor: 350 W
 Pressure: 25 kg
 Water level: 1100 mm

Fresh water volume: 13 l
 Sewage tank volume: 16 l
 Working width: 350 cm
 Suction width: 500 cm
 Weight: 38 kg (without accu)

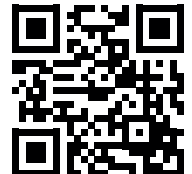

Webcode: #gmpi

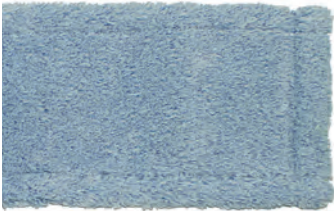
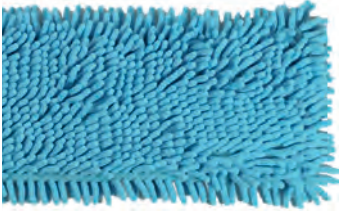

Microfibre

Microfibres are very thin and soft, but even steady and tear-resistant fibres. These specifications allow an wide area of operations: microfibre textiles are suitable for wiping and polishing as well as for dedusting.

Because of the enormous fineness, that lies between 0,1 and 1,0 dtex (for comparison: the fineness of cotton fibres lays between 1,5 and 2,5 dtex), the production of microfibres ist very complicated. In simple terms, homogeneous polymeres (plastic) are melted and spinned to a fibre. The regular spinning process hast to be adjusted, because microfibres only can be produced on a very high spinning speed. This high speed results to a parallel arrangement of molecules, which guarantees robustness and tear-resistency, in spite of the fibre fineness.

10.000 metres of this thin fibre only weigh 1 gram. Microfibres are three times thinner than cotton fibres and 100 times thinner than human hair. But compared with other materials they have a higher volume. As a result microfibre mops have a good dirt absorbability due to their larger surface. The thin mesh goes even in micropores of structured surfaces and therefore remove tenacious dirt easily without being prone to fluff.



Cotton

Cotton mops are made from cotton fibres (natural fibres) that are extracted from cotton plants. Normally cotton mops consist of a mixture of cotton and polyestreto avoid shrinking during washing. The diametre of a fibre is 12-35 μm .

Compared to microfibre cotton is very absorptive and kann absorb up to 65 percent of its own weight. But the drying time is much longer than for microfibres. Cotton has a high dirt and oil capacity and escaping power. Therefore cotton mops are ideal for floor cleaning and coating.



i International Agencies:

 Austria	 Poland
 Belgium	 Portugal
 Croatia	 Slovenia
 Czech Republic	 Syria
 Finland	 Turkey
 France	 Ukraine
 Great Britain	
 Greece	
 Hungary	
 Italy	
 Ireland	
 Latvia	
 Lithuania	
 Luxembourg	
 Malta	



An institution in the cleaning industry – over 90 years of tradition and experience

In 1923 Willy Oehme, Nuremberg, founded the Lorito S.A. in Vevey, Switzerland, at the Lake Geneva. At that time the range of products was limited to the Creme Lorito, a universal cleaning agent for the “housewife” to clean, polish and disinfect wood, leather, linoleum and other Types of solid surfaces. The creme is produced to this day.

In 1970 his son Otto Oehme (top right picture) took over the company that now had its place of business in Wendelstein south of Nuremberg. The newly founded Otto Oehme GmbH (a liwited company) shifted its focus to business clients and broadened its portfolio of products gradually. In 1998 the company moved to the current premises in Allersberg that house management as well as production. For better market coverage further associated companies were founded in Berlin, Brunswick, Hannover, Leipzig and Frankfurt.

To maintain the continued existence of the company Ulla Oehme and Klaus Krisch joined management in 2003. Two years later the company expanded and multiple foreign subsidiaries were founded – at the moment the Otto Oehme GmbH is represented in more than 20 countries. Large-scale consumers in Germany and the EU are supplied by the company’s own private haulage. In the meantime the range of products has been extended to additives, auxiliary equipment and machines.

In 2010 Ulla Oehme took over some company shares and is now an owner of the company as well – in the third generation by now.

Our ambition

Due to our variety of special cleaning agents and machines we offer a complete solution for cleanliness and hygiene. Our skilled consultants attend to your needs. We organize seminars for our customers, led by well-known instructors, on a regular basis.

Committed to the environment

The Otto Oehme GmbH is a member of multiple research communities and professional associations (such as IHO, IKW, VCI, FRT, ARGEB) as well as a participant in the “Environmental Pact” of Bavaria (Umweltpakt Bayern). Since 1923 all compositions of cleaning agents and care products have always been produced in-house. They are free of CFC, chlorocarbons and aromatic solvents. In order to meet our ecological and economic obligations, we use renewable raw materials wherever possible.

Furthermore, all of our cleaning agents comply with legal regulations by directive 1999/45/EC of the EU (relating to the classification, packaging and labelling of dangerous preparations), the German Detergent and Cleaning Agent Act (Wasch- and Reinigungsmittelgesetz – WRMG, 1987), the German Chemicals Act (Chemikaliengesetz – ChemG, revision 2002) and Hazardous Substances Ordinance (Gefahrstoffverordnung – GefStoffV, 2010).

That means that our products – when used properly – will not endanger the physical health of a person. The forceful legislation of the EU, particularly the Regulation on Registration, Evaluation, Authorisation and Restriction of Chemicals (REACH), that makes special demands on environmental pretection as well as health pretection, is strictly adhered to at all times.

If procurable we outrun these legal guidelines and offer our customers products with maximal environmental sustainability and user pretection. Thus, for example, we offer products following Decision 2005/344/EC by the EU, a regulation for the EU Ecolabel. For these products an environmental assessment process according to a special questionnaire is no longer necessary. Our disinfectants are listed by the Association for Applied Hygiene (Verband angewandter Hygiene – VAH, former DGHM), several sanitary cleaners are included in the RK-list.

Please get in touch with us, we gladly advise you.

Your Otto Oehme GmbH

Imprint

Published by:
Otto Oehme GmbH
Industriestr. 20
90584 Allersberg
Germany
Tel: +49 (0) 9176 / 98 05 0
Fax: +49 (0) 9176 / 98 05 55
E-mail: info@oehme-lorito.de

HRB 4318, Amtsgericht Nürnberg
VATIN: DE 133 531 484
Court of jurisdiction: 91126 Schwabach

Responsible for content: Otto Oehme GmbH
Editor: Carlos Oehme
Design & layout: fp360 new media

Associated Companies:
Berlin
Otto Oehme GmbH
Lorito Vertrieb Berlin
Meeraner Str. 13 f
12681 Berlin, Germany
Tel: +49(0) 30 / 559 686 4
Fax: +49(0) 30 / 550 959 5
E-mail: info@oehme-berlin.de

Leipzig
Otto Oehme GmbH
Lorito Vertrieb Leipzig
Lindenthaler Hauptstr. 135
04158 Leipzig, Germany
Tel: +49(0) 341 / 234 196 0
Fax: +49(0) 341 / 234 196 1
E-mail: lorito-leipzig@gmx.de

Brunswick
Sefin Lorito Vertriebs GmbH
Marienberger Straße 1
38122 Braunschweig, Germany
Tel: +49(0) 531 / 871 902
Fax: +49(0) 531 / 871 990
E-mail: info@sefin.de

Frankfurt
Otto Oehme GmbH
Lorito Vertrieb Frankfurt
Oberurseler Straße 73
61440 Oberursel, Germany
TEL: +49 (0) 176 / 311 145 99
FAX: +49 (0) 6171 / 507 731
E-mail: klaus.peiner@gmx.de

Adaptor for Hitachi nozzles	39	Mopping carts	12-16
Aluminium sticks	20	Multipurpose tools	39
		Nozzles	39
Bin liner	19	Pads	18
Blade holder	8	Paper bin	24
Blades	8	Paper dispenser	24
Brooms	20	Paper filters	40
Broom sticks	20	Paper towels	24
Brushes	20	Parquet tools	39
Buckets	19	Plastic bags/sacks	19
Bucket system carts	12-15	Plastic buckets	24
		Polishing machines	42
		Power cable	40
Cartridges for soap dispenser	25	Quiver for tools	8
Caution signs	22	Roll press system	16, 19
Ceiling brushes	21	Rubber strips for window cleaners	8
Cleanfix machines	45, 46	Sanitary brushes	21
Cleaning machines	42-46	Scratcher	8
Cleaning trolleys	28-30	Scrubber dryers	45-46
Cleansing tissues	24	Shoe pads	18
Combined floor tool	39	Single disc machines	42-43
Crevice nozzle	39	Skin care creme	26
Deodorizer clips	24	Soap dispensers	25
Dirt eraser Pumie	26	Special mops	10-11
Disinfectant trough	19	Spiral scouring pad	18
Double bucket system trolleys	14, 15	Sponges	18
Dust cloths	8, 18	Spray extraction machines	44
Dustpan	21	Spray can	22
		Suction tubes	40
Feather duster	21	Superpads	18
Fleeze cloths	18	System carts	28-30
Floor tools	39		
Foam soap dispenser	25	Telescopic sticks	8
Folding flat mop frames	11	Toilet brush	26
Fork mop	22	Toilet paper	24
Funnel tube	26	Tool handles	20
		Towels	8, 18
Gaze cloths	9	Trolleys	28-32
Glass scraper	8	Troughs	19
Gloves	22	Turbo nozzles	39
		Two-chamber mopping cart	16
Handpad	18	Urinal deodorizer	24
Heater brush	21	Vacuum cleaners	34-35
Hose sets	39	Washer sleeves	8
Hotel trolleys	31	Waste bins	26
Hygienic paper	24	Waste picker	22
Hygienic pouches and dispenser	24	Waste trolleys	32
		Water pushers	21
Jumbo roll mount	24	Wet and dry cleaners	36-37
		Wet mops	10, 11
Kitchen rolls	24	Wet mop x-mount	9
Knapsack exhauster	38	Window cleaners	8
		Window washer holders	8
Laundry trolleys	32		
Metal scraper	22		
Microfibre mops	10-11		
Microfibre towels	18		
Moist mops	9		
Moist wiping handles	9		

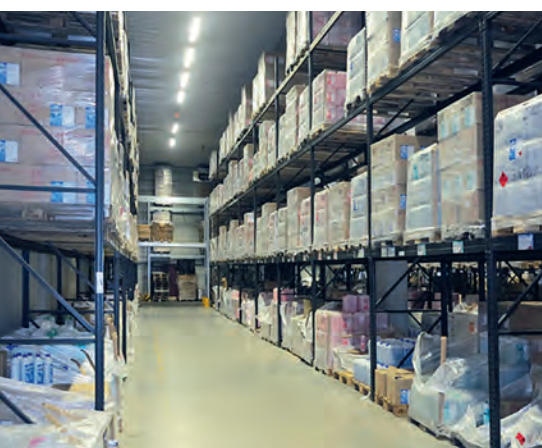

Content

Mopping Systems	7
Glass Cleaning	8
Moist Mops	9
Special Wet Mops	10
Wet Mops and Bucket Systems – Single Bucket Systems	12
Wet Mops and Bucket Systems – Double Bucket Systems	14
Wet Mops and Bucket Systems – Mopping Carts	16
Auxiliary Equipment and Accessories	17
Cloths, Sponges, Pads	18
Plastic Buckets & Bags	19
Brushes & Brooms	20
Other Equipment	22
Sanitary Equipment and Accessories	23
Hygienic Paper & Dispensers	24
Soap Dispensers	25
Other Accessories	26
Cleaning & Hotel Trolleys	27
Vacuum Cleaners	33
Vacuum Cleaners	34
Wet and Dry Cleaners	36
Upright Vacuum Cleaners	38
Accessories for Vacuum Cleaners	39
Cleaning machines	41
Single Disc Machines	42
Spray Extraction Machines	44
Scrubber Dryers	45
QR Codes in this Catalogue	4
Product List	5
Overview: Mop Materials	47
Distribution Network	48
Index	51



QR Codes In This Catalogue

Get product information faster and more precise

QR codes ("quick response") are two-dimensional bar codes which enable quick access to the internet via a camera of a smartphone or tablet. A QR code reader installed on the device is required but you can get one on the internet for free.

Benefits of QR codes

As the name suggests the QR code directs the user straight to the product page in the Oehme Lorito download centre. There you can access and download all information on a certain product quickly and easily. On the particular product page you can find all available safety and product data sheets and a picture as well as characteristics and operating instructions.



Use of QR codes in this catalogue



A | If this has not yet been done, install a QR code reader on your smartphone or tablet. You can find app recommendations with shortlinks to download them in the infobox beneath.

i

QR code reader for Apple iOS:

„Scan“ for Phone, iPad, iPod touch

„QR Reader for iPhone“ - free

„QR Reader for iPad“ - free

<http://oehme-lorito.de/qr-ios>

<http://oehme-lorito.de/qr-iphone>

<http://oehme-lorito.de/qr-ipad>

for Android:

„Barcode Scanner“ - free

<http://oehme-lorito.de/qr-android>



B | Scan the QR code next to the desired product in the catalogue with the app. You are then directed to the product page in the Oehme Lorito download centre. There you can directly access and download safety and product data sheets.



C | In case of problems concerning the use of QR codes you can also open the Oehme Lorito download centre in the browser of your mobile phone or computer manually:

1. Go to <http://www.oehme-lorito.de>.
2. There is a search window on the welcome page where you need to Type in the name of the product, the number or the webcode (e.g. #2d2d)
3. Click / tap on "search"
4. Open the product page by clicking / tapping on the product name or picture.

Product List

2-chamber bucket	16	Jumbo roll mount	24	Single chromed	12
Accessories for window cleaners	8	Latex gloves	22	Soap dispenser	25
Adaptor for Hitachi nozzles	39	Laundry trolley „Steve“	32	Socket cleaning brush	26
BF 520	43	Level-duo	15	Special mops	10
BF 521	42	Lorito Baby	35	Special mops microfibre	11
BF 584 A-3 with suction cart	37	Lorito Profi	34	Sponges	18
Brooms 1-hole-system	20	Lorito Silent 10 / 15	34	Spray cans	22
Brooms and brushes powerstick	20	Lorito SW 38	36	Spray extraction machine	44
Brooms and brushes 4-hole	20	Lympia 13	43	Suction tubes	40
Bucket systems	15	Metal scraper	22	Superpads	18
Blade holder	8	Microfibre mops	10	SW 30 Cleanair	37
		Microfibre special mops	10, 11	SW 55 Cleanair	37
C 143 OLN	42	Microfibre towels	18	SW 75 Cleanair	37
C 143 TSN two speed	42	Minispeed 350E/B	46	SW 93	36
C 150 L 16	43	Moist mops	9	Telescopic handles	8
C 150 U 13	42	Moist wiping frames	9	Thommy, Thommy Duo	31
Cartridges for soap dispenser	25	Mopping cart „Maxi“ with press	16	Tool handles	20
Caution signs	22	Multipurpose tool	39	Tool handles 4-hole	20
Cleanfix S10 Plus	35			Toilet brush	26
Cleaning trolley „Max“	30	Paper filters	40	Turbo nozzle	39
Cleaning trolley „Willy“	30	Paper towel dispensers	24	Two-roll cleaning machine	45
Cloths	18	Paper bins	26	Urinal deodorizer	24
Crevice nozzles	39	Parquet tool	39		
Combined floor tools	39	Parquet mops	9	Washer sleeves	8
		Plastic buckets, rectangular	19	Waste bin	26
Deodorizer clips	24	Plastic buckets, round	19	Waste picker	22
Deodorizer „Curve“	24	Plastic bags / bin liner	19	Waste trolley X-form	32
Disinfectant troughs	19	Pumie dirt remover	26	Water mover	21
Double bucket systems	14, 15	Power cables	40	Wet mops	11
Duo chromed	14			Wet mop x-mount	9
Duo frame foldable	15	Quick mops	11	Window washer	8
Duo plastic	14	Quiver for tools	8	Window washer holder	8
Duo plastic „KURT“	14				
Dustpan and broom	20	RA 300 E	45		
		RA 431 B	45		
Feather duster	21	RA 431 E	45		
Floor and ceiling brushes	21	RA 501 B	45		
Floor and window scraper	8	RA 501 E	45		
Foam soap dispensers	25	RA 605 IBCT	46		
Folding flat mop frames	11	Riloto peach soap	25		
Fork mops	22	Roll press system	16, 19		
Fuginator	26	Ruck Zuck knapsack exhauster	38		
Funnel tube	26				
		Sabrina	44		
Gaze cloths	9	Sabrina maxi	44		
Glass cleaning cloths	8	Sanitary brushes	21		
Gloves	22	SEBO 36 Comfort	38		
		SEBO 46 Comfort	38		
Handpads & holder	18	Serie 105	28		
Heater brush	21	Serie 106	28		
HERWE Cura skin care	26	Serie 107	28		
Hitachi CV-300, CV-300 P	34	Serie 108	29		
Hitachi CV-400	34	Serie 203	29		
Hitachi CV-950 BK	35	Serie 204	29		
Hose set complete	39	Serie 209	15		
Hotel trolleys	32	Shoepads	18		
HS 2000	43	Single chromed, foldable	13		
Hygienic pouches and dispenser	24	Single plastic	12		
Hygienic paper	24	Single plastic „KURT“	12		

Four-Colour-System

Mix-up impossible – one colour for each application

The well-established Four-Colour-System ensures hygiene while cleaning surfaces above the ground. The colour system allows an easy optical separation of cleaning equipment like cloths, sponges, buckets or cleaning agents. An consequent application of this colour system not only optimises hygiene, but also simplifies the cleaning management.

The system consists of four basic colours: red, yellow, blue and green, whereat each colour represents an specific application area. Thus it avoids the usage of a cloth, that has been used for the toilet before, for cleaning the desk and therefore transmitting germs to furnishings.

The following colour codes are well-established in practice:



Sanitary areas (toilet, urinal)

for sanitary areas with high bacterial contamination like toilets, urinals, bidets and its splash zones. Hygiene has the highest priority in these areas.



Sanitary areas (other areas)

for the general sanitary areas, which have a lower bacterial contamination, like sinks, mirrors, bathtubs, taps. To avoid bacterial dissemination to other, non-sanitary areas.



General cleaning

for the general cleaning of surfaces like furnishings, doors, lamps and windows in the office or lobby.



Kitchen/special assignment

for areas that encounter food like kitchens, cafeterias and recreation rooms. Also suitable for special assignments like operation rooms, glass cleaning or floors.

Every public space like schools, kindergardens, day-care centres and hospitals is obligated to use a colour system for separation.

Glass Cleaning

Window cleaners

stainless steel, with rubber



Item No.	Item	Size
401225	blue	25 cm
401235	blue	35 cm
401245	blue	45 cm
401255	blue	55 cm
454125	black	25 cm
454135	black	35 cm
454145	black	45 cm
454155	black	55 cm
403030	2-in-1 combo	25 cm

Window washer holder

Item No.	Item	Size
457408	plastic, black	25 cm
401030	plastic, blue	35 cm
401031	plastic, blue	45 cm
457501	plastic, black	55 cm

Blade holder

Item No.	Item	Size
456600	blade holder patented	10 cm
456400	blade	10 cm
466807	ceramic glass scraper	4 cm

Floor and window scraper

with plastic grip

Item No.	Item	Size
401090	working width 10 cm	22 cm
401091	working width 10 cm	120 cm
466900	special scraper	10 cm

Accessories for window cleaners

Item No.	Item	Size
401070	rubber strip, black	25 cm
401071	rubber strip, black	35 cm
401072	rubber strip, black	45 cm
454501	rubber strip, blue	35 cm
454601	rubber strip, blue	45 cm
454801	rubber strip, blue	105 cm

Washer sleeves

Item No.	Item	Size
A 457201	white	25 cm
A 401040	white	35 cm
A 401041	white	45 cm
A 457200	white	55 cm
B 457001	blue with pad	35 cm
B 457101	blue with pad	45 cm
B 457102	blue with pad	55 cm
C 456701	super quality	35 cm
C 456801	super quality	45 cm
C 456702	super quality	55 cm
D 457225	chenille	25 cm
D 457235	chenille	35 cm
D 457245	chenille	45 cm

Quiver for tools

for window washer, cleaners etc.

Item No.	Item
457602	quiver, plastic
454412	belt for quiver

Telescopic tube aluminium

exchangeable conus, black handle

Item No.	Item	Size
A 455610	two-piece, 2,5 m	2x1,25 m
A 455710	two-piece, 4 m	2x2,00 m
A 455810	three-piece, 6 m	3x2,00 m
A 455910	three-piece, 9 m	3x3,00 m

Accessories

B 449910	conus for telescopic tube
C 456200	universal clip metal, suitable for telescopic tube with exchangeable conus
D 459290	wall and ceiling broom, attachable on telescopic tube

Glass cleaning cloths

Item No.	Item	Size (ca.)
A 669101	chamois leather (6 qfs)	85x70 cm
B 457600	emery cloth	60x70 cm
C 651711	professional room care cloth, perforated, super quality	35x40 cm
D 651712	professional room care cloth with pictogram, red, green, blue	35x40 cm
E 453702	window cloth, ripped microfibre, blue, red, green	40x40 cm
F 453718	Lorito Bambu, red	40x40 cm
F 453719	Lorito Bambu, blue	40x40 cm
453714	Flauschi, blue, red, green, yellow	40x40 cm

Moist Mops



Moist mop covers with polyester back

cotton, washable at 50°

Item No.	Item	Size
B 461401	with bags	40 cm
A 461503	with ribbon	60 cm
B 461502	with bags	60 cm
B 461602	with bags	80 cm
A 461603	with ribbon	80 cm
A 461700	with ribbon	110 cm
A 461801	with ribbon	130 cm
C 461912	with ribbon	160 cm



Moist mop

Item No. 419000

blue, Synthetic, 60 cm, washable at 60°

other sizes on demand



Moist wiping frames

Item No.	Item	Size
460900	plastic	60 cm
461000	plastic	80 cm
461100	metal	110 cm
461200	metal	130 cm
461300	metal	160 cm



Gauze cloths

for moist mops with central hole, seamed

Item No.	Item	Size (ca.)
463000	gauze cloth	80x60 cm
463100	gauze cloth	80x90 cm
463200	gauze cloth	80x120 cm
463300	gauze cloth	80x150 cm
463400	gauze cloth	80x180 cm



Special cleaning cloth

Item No.	Item	Size (ca.)
437200	cloth with high dirt holding capacity, yellow	60x60 cm
437300	cloth with high dirt holding capacity, yellow	22x60 cm
437350	cloth with high dirt holding capacity, yellow	60x25 cm
437100	trapeze mop, blue	60 cm



Trapeze mop

Item No.	Item	Size
437100	trapeze mop	60 cm
437110	trapeze mop with hook-and-loop tape, for window cleaning	30x8 cm
444045	hook-and-loop mop 80% polyester, 20% polyamide, washable up to 60°C	30x10 cm



Special wet mop X-mount

Item No. 416800

Accessories	Item	Size
416900	wooden rack, 2x110 cm	
416910	handle with metal stirrup	
417000	cotton cover, 110 cm	



Parquet mops

100% polyester, black/white mottled, washable up to 95°C

Item No.	Item	Size
471500	with bags	60 cm
471600	with bags	80 cm
471400	with fringe	40 cm
471300	with fringe	60 cm
471200	with fringe	80 cm

Special Wet Mops



Special mop "Ida"

washable at 95°, polyester back and bags, with soft inlays

Item No.	Item	Size
443660	mesh/fringe	40 cm
443670	mesh/fringe	50 cm



Special mop "Carola"

washable at 60° C, polyester back and bags, green fringe ribbon, 230 g

Item No.	Item	Size
414230	mesh/fringe	40 cm
414240	fringe/fringe	40 cm
414250	mesh/fringe	50 cm
414260	fringe/fringe	50 cm



Special wet mops tufted

50% cotton / 50% polyester

Item No.	Item	Type	Size
A 414380	"First"	tufted	40 cm
A 414385	"First"	tufted	50 cm
B 414390	"Second"	tufted	40 cm
B 414395	"Second"	tufted	50 cm



Microfibre special mop chenille "Professional", "Calito"

for wiping, dedusting and polishing

Item No.	Item	Type	Size
447051	chenille "Professional"	blue	40 cm
447052	chenille "Professional"	blue	50 cm
447053	chenille "Professional"	red	40 cm
447054	chenille "Professional"	red	50 cm
447001	"Calito"	blue	40 cm
447002	"Calito"	red	40 cm
447003	"Calito"	blue	50 cm
447004	"Calito"	red	50 cm



Microfibre mops

Item No.	Item	Type	Size
469040	Augustin, plush	white	40 cm
469050	Augustin, plush	white	50 cm
467020	special microfibre mop with grey active-microfibre stripes	white/grey	40 cm
467021	special microfibre mop with grey active-microfibre stripes	white/grey	50 cm
469060	microfibre mop "Augustus" ECO plush	white	40 cm
469065	microfibre mop "Augustus" ECO plush	white	50 cm



Special mop "Carlos"

100 % cotton, with colour coding

Item No.	Item	Type	Size
424240	mesh/fringe	white	40 cm
424250	mesh/fringe	white	50 cm

Special Wet Mops



Special mop microfibre, microfibre "Franzi"

with water depot

Item No.	Item	Type	Size
467040	water depot, blue-mottled, long fibre	112 g	40x12 cm
467041	water depot, blue-mottled, long fibre	152 g	50x14 cm
467044	"Franzi", water depot		40x12 cm
467055	"Franzi", water depot		50x14 cm



Special mop microfibre

with colour coding

Item No.	Item	Size
467057	blue, with colour coding	40 cm
467058	blue, with colour coding	50 cm



Stripe mop

70% polyester, 20% polypropylene, 10% polyamide, washable at 95° C

Item No.	Item	Size
414170	grey-blue	40 cm
414180	grey-blue	50 cm



Quickcovers

PVC/nylon buttstrap

Item No.	Item	Size
418710	mesh/fringe	40 cm
418310	mesh/fringe	50 cm

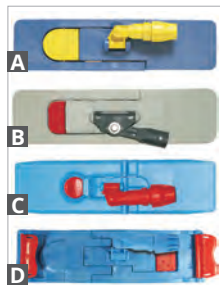

Folding flat mop frames

Item No.	Item	Size
A 443046	magnetic folding flat mop frame, blue/yellow	11x40 cm
A 443047	magnetic folding flat mop frame, blue/yellow	13x50 cm
B 454040	magnetic folding flat mop frame "Petra"	11x40 cm
B 455040	magnetic folding flat mop frame "Petra"	13x50 cm
C 419560	folding flat mop frame for disinfection	11x40 cm
C 419550	folding flat mop frame for disinfection	13x50 cm
D 418550	fast folding flat mop frame "Charly"	11x40 cm
418500	fast folding flat mop frame "Ida"	13x50 cm



Wet mop mounts

Item No.	Item
458201	blue
458202	red
458203	yellow
458204	green



Wet mop I

cotton, with ribbon

Item No.	Item
458400	ca. 390 g
458500	ca. 450 g

other sizes on request

Hint

You find a detailed overview and description of the available mop materials on page 47.

Wet Mops and Bucket Systems – Single Bucket Systems



Single plastic Item No. 469900

Single plastic frame for one bucket (17/25 l) without handle

Item No.	Item	Size
469880	complete	25 l
469881	complete	17 l
469885	with special accessories (see right figure)	17/25 l

Optional Accessories

419801	plastic roller	
K 428100	plastic basket for materials	
N 449700	handle	
A 457810	plastic bucket (red, blue, green, yellow), rectangular, 4 l	
457811	bucket holder for 4 l bucket	
B 459700	plastic bucket (red, blue), rectangular, 25 l	
B 460000	plastic bucket (red, blue), rectangular, 17 l	
T 463610	bag holding frame, 60 l	
463611	holder for bag holding frame and bucket holder	
I 463613	box holder for bottle rack	
464210	stick holder with snap fit	
P 468400	plastic press	
463612	bottle holder/tray	



Mopping cart system "Single Kurt", plastic Item No. 469899

inclusive 1 x 25 l bucket, press K

Optional Accessories

D 469894	plastic shell	
M 469896	handle	



Mopping cart system "Single" chromed Item No. 459900

Single frame chromed for one bucket (17/25 l), roller Ø 75 mm, rubber protection

Item No.	Item	Size
459717	complete with press I	17 l
479717	complete with press P	17 l
459725	complete with press I	25 l
479725	complete with press P	25 l

Optional Accessories

L 459600	handle chromed	
B 459700	plastic bucket (red, blue), rectangular, 25 l	
B 460000	plastic bucket (red, blue), rectangular, 17 l	
P 468400	plastic press	
R 464603	gabion cage for equipment (mounted on handle)	

Wet Mops and Bucket Systems – Single Bucket Systems



Mopping cart system "Single" chromed, foldable Item No. 459910

chromed, incl. handle

Item No.	Item	Size
459917	complete	17 l
459925	complete	25 l

Optional Accessories

B 459700	plastic bucket (red, blue), rectangular, 25 l
B 460000	plastic bucket (red, blue), rectangular, 17 l
P 468400	plastic press
R 440472	gabion cage for equipment (mounted on handle) – similar look like figure R, just thinner
Q 428001	gabion cage, 2 x 5 liter buckets– similar look like figure Q

Accessories for Single and Double Bucket Systems



Wet Mops and Bucket Systems – Double Bucket Systems

**Mopping cart frame "Duo", plastic** Item No. 469800

Duo plastic frame for two buckets (17/25 l) without handle

Item No.	Item	Size
469891	complete	2 x 17 l
469890	complete	2 x 25 l
469895	complete, with optional accessories	2x 17/25 l

Optional Accessories

O 281001	handle	
K 428100	plastic basket for materials	
A 457810	plastic bucket (red, blue, green, yellow), rectangular, 4 l	
457811	bucket holder for 4 l bucket	
C 459311	rectangular bucket with cover	
B 459700	plastic bucket (red, blue), rectangular, 25 l	
B 460000	plastic bucket (red, blue), rectangular, 17 l	
463611	holder for bag holding frame and bucket holder	
J 463612	bag/bottle rack	
I 463613	boxholder for bottle rack	
464210	stick holder with snap fit, Ø 22 mm	
H 464011	plastic rack	
P 468400	plastic press	
306010A	holding frame with cover for plastic bags, 120 l	

**Mopping cart system "Duo Kurt", plastic** Item No. 469898

Incl. 2x25 l bucket, press K, handle and plastic shell/basket for materials

Optional Accessories

B 459700	plastic bucket (red, blue), rectangular, 25 l	
D 469894	plastic shell	
M 469896	handle	

**Mopping cart frame "Duo" chromed** Item No. 459800

Duo frame chromed for two buckets (17/25 l), rolls Ø 75 mm, rubber protection, fixed press holder

Item No.	Item	Size
459817	complete with press I	2 x 17 l
459825	complete with press I	2 x 25 l
479817	complete with press P	2 x 17 l
479825	complete with press P	2 x 25 l

Optional Accessories

440471	plastic basket for materials	
L 459600	handle chromed	
B 459700	plastic bucket (red, blue), rectangular, 2x25 l	
B 460000	plastic bucket (red, blue), rectangular, 2x17 l	
P 468400	plastic press	



Wet Mops and Bucket Systems – Double Bucket Systems

**Mopping cart frame "Duo" foldable** Item No. 459810

chromed, incl. handle

Item No.	Item	Size
459617	complete	2x17 l
459625	complete	2x25 l

Optional Accessories

B 459700	plastic bucket (red, blue), rectangular, 2x25 l
B 460000	plastic bucket (red, blue), rectangular, 2x17 l
P 468400	plastic press
440472	gabion cage for equipment (mounted on handle)

**Mopping cart system "level-duo"** Item No. 464646

basic frame "levelduo" (two-step), plastic trough, gabion cage, plastic press with stick holder and splash guard, 2 x bucket 17 l, blue or red.

Optional Accessories

B 460000	plastic bucket (red, blue), rectangular, 17 l
G 464602	plastic trough
R 464603	gabion cage for equipment (mounted on handle)
P 468400	plastic press

**Mopping cart system "Duo Saggi"** Item No. 450210

basic frame, handle, gabion cage for 2x5 l buckets, rectangular bucket 5 l red and blue, rectangular bucket 17 l red and blue, plastic shell sideways, plastic shell centered, gabion cage sideways.

Item No.	Item
468410	with plastic press P

Optional Accessories

450212	handle
F 450214	plastic shell sideways
E 450213	plastic shell centered
Q 450215	gabion cage, 2 x 5 liter buckets
450216	plastic bucket (red, blue), rectangular, 5 l
S 450217	gabion cage sideways
B 460000	plastic bucket (red, blue), rectangular, 17 l

**Double bucket system - 209 series** Item No. 450209

with press. chromed frame, 2x17 l bucket (red, blue), plastic press, grate, bucket for materials, holding frame, 70 l

Wet Mops and Bucket Systems – Mopping Carts



Roll press system Item No. 428810
15 l volume, removable divider, foot controlled roll press



2-chamber mopping cart
Item No. 459208
19 l, incl. press, with removable divider, ca. 7 l volume each chamber



Mopping cart "Maxi" with press

incl. press

Item No.	Item	Size
467970	yellow	25 l
467960	blue	25 l
467965	red	25 l
467975	green	25 l

Rectangular bucket with cover and rolls

Item No. 457706
22 l, blue, ca. 42x32x24 cm, with 4 removable rolls



Cloths, Sponges, Pads

Superpads

White, fawn, green, red, blue, black. More sizes on request.



Item No.	Item	Type	Size (ca.)
Superpad 41_Colour		White, fawn, green, red, blue, black	41 cm
Superpad 46_Colour		White, fawn, green, red, blue, black	46 cm
Superpad 51_Colour		White, fawn, green, red, blue, black	51 cm
468983	melamine pad for special cleaning		

Shoe pad with elastic band



Item No.	Item
462610	white
462620	green
462625	black
462626	red

Hand pads and mount



Item No.	Item	Size (ca.)
462500	hand pad	16x23x1 cm
462600	super hand pads	12x25x2,5 cm
462700	hand block	10x23 cm
462800	stick block	10x23 cm
468984	dirt eraser hand pad	
462760	dirt eraser white melamine	

Microfibre towels

Lorito Bamboo: with 50% mikrofibre and 50% bamboo fibre.

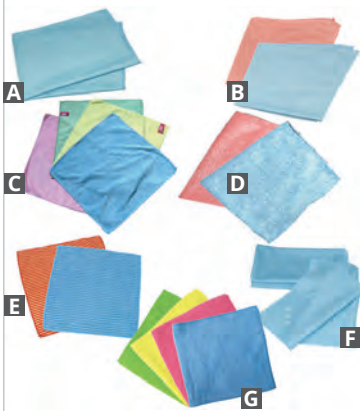

Item No.	Item	Type	Size (ca.)
A 453700	Loritex	pink, blue, yellow, green	40x40 cm
B 453702	window towel ripped	blue, red	40x40 cm
C 453709	KOI	red, blue, yellow, green	40x40 cm
D 453710	Loritex Light	blue	40x40 cm
D 453711	Loritex Light	red	40x40 cm
E 453718	Lorito Bamboo	red	40x40 cm
E 453719	Lorito Bamboo	blue	40x40 cm
F 453730	Xtrafine	blue	40x40 cm
F 453727	Xtrafine	red	40x40 cm
F 453729	Xtrafine Maxi	blue	50x70 cm
F 453730	Xtrafine Maxi	red	50x70 cm
G 453714	Flauschi	blue, red, green, yellow	40x40 cm

Cloths

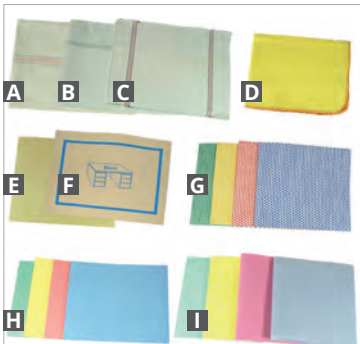

Item No.	Item	Type	Size (ca.)
A 651300	floor cloth, extra strong	cotton	50x70 cm
B 651400	fleece pick-up	synthetic	50x70 cm
C 651500	waffle wipe	cotton	35x35 cm
D 651600	duster	yellow	40x50 cm
651702	cleansing wipe, unperforated	red, blue, yellow, green	35x40 cm
E 651711	professional cleansing wipe, perforated	super quality	35x40 cm
F 651712	professional cleansing wipe, perforated	super quality with pictogram	35x40 cm
G 652400	general-purpose cloth	red, blue, yellow, green	30x40 cm
H 653400	sponge cloth	red, blue, yellow, green	25x31 cm
I 653900	general-purpose fleaze cloth	yellow, pink, blue, green	38x40 cm

Sponges



Item No.	Item	Type	Size (ca.)
415900	blackboard eraser		15,5x11x6 cm
462300	sponge pad with recessed grip	yellow-green	15x8 cm
462400	sponge pad with recessed grip	blue-white	13x7 cm
462410	sponge pad with recessed grip	red-white	13x7 cm
462420	sponge pad with recessed grip	yellow-white	13x7 cm
462421	sponge pad with recessed grip	green-white	13x7 cm
422222	spiral scouring pad, 60 g		
462760	sponge eraser		

Plastic Buckets & Bags



Disinfection trough

Item No.	Item	Size
463641	plastic, blue	35 l
464641	plastic, blue	45 l



Plastic buckets, round

Item No.	Item	Size
652900	bucket, blue, red	5 l
652800	bucket, blue, red	10 l
411200	massive bucket, black	12 l



Plastic buckets, rectangular

Item No.	Item	Size
A 457810	red, blue, yellow, green	4 l
459400	red, blue, yellow, green	6 l
459300	red, blue, yellow, green	12 l
B 460000	with bucket spout, 27x27x28 cm, blue, red	17 l
C 459700	with bucket spout, 30x30x35 cm, blue, red	25 l
457700	40x20x20 cm, red - for window cleaning	12 l
457702	with plastic sieve and rolls, yellow	22 l
460001	red, blue with bucket spout	17 l
457701	rectangular bucket, blue	22 l
422700	rolls for item 457701	
422500	bucket grid for item 457701	



Plastic bags / bin liner

Bin liner and plastic bags in different material thicknesses, colours and sizes available.

Item No.	Item	Size
459095	paper back, brown with imprint "Abfall" (waste)	120 l
512100	HDPE bin liner transparent, 100 piece roll, ca. 450x520 mm	16 l
528501	bin liner grey, 30 piece roll	30 l
564074	Linothene blue, extra strong, 25 piece roll, ca. 700x1100 mm	120 l
565300	LDPE-bin liner blue, 25 piece roll, 700+200x1100 mm	140 l
565500	LDPE-bin liner BRILLANT A, black, 25 piece roll, ca. 700x1100 mm	120 l
565501	LDPE-bin liner BRILLANT B, light blue, 25 piece roll, ca. 700x1100 mm	120 l
565510	bin liner Type 100, dark blue, 15 piece roll	120 l
565600	LDPE-bin liner Type 60, light blue, 25 piece roll, ca. 575x1000 mm	70 l
565700	HDPE-bin liner eco, transparent, 50 piece roll, ca. 700x1100mm	120 l
565900	HDPE-bin liner transparent, 50 piece roll, ca. 500x600 mm	30 l
569855	HDPE-bin liner hostess, white, 40 piece roll, ca. 630x850 mm	60 l



Roll press system, yellow

Item No. 428810
15 l, 2 chambers

Brushes & Brooms



Brooms and scrubbers 4-hole patented system

Item No.	Item	Size
A 650000	nylon broom, wooden frame	30 cm
B 650200	street broom, elastane	60 cm
650250	street broom, elastane	40 cm
C 650300	coconut fibre broom	40 cm
650400	coconut fibre broom	60 cm
650401	coconut fibre broom	80 cm
D 650500	house broom, mixture hair	30 cm
E 650600	industrial broom, mixture hair	40 cm
650700	industrial broom, mixture hair	60 cm
650701	industrial broom, mixture hair	80 cm

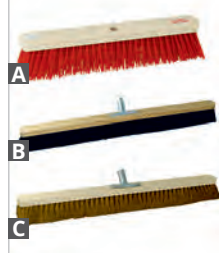

Brooms 1-hole system

Item No.	Item	Size
A 248200	professional street broom, elastane with wooden stick (140cm)	40 cm
248600	professional street broom, elastane with wooden stick (140cm)	60 cm
B 660500	industrial broom, high-quality material with metal stick holder	80 cm
C 660800	industrial broom, coconut fibre with metal stick holder	80 cm

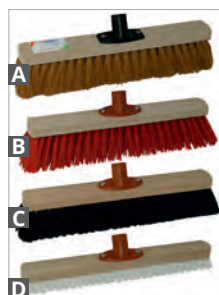

Brooms and scrubbers 1-hole-system with powerstick mount

Item No.	Item	Size
A 231093	industrial broom, coconut fibre	40 cm
231493	industrial broom, coconut fibre	60 cm
B 234093	industrial broom, elastane	40 cm
234393	industrial broom, elastane	60 cm
C 238393	industrial broom, mixture hair	40 cm
238693	industrial broom, mixture hair	60 cm
D 320593	PPN wipe	30 cm
320993	PPN wipe	40 cm



Tool handles

Item No.	Item	Size
413600	glass fibre stick	1,40 m
457920	aluminium stick, blue	1,40 m
457910	telescopic stick, aluminium	1,50 m
452300	wooden stick, unpainted	1,40 m

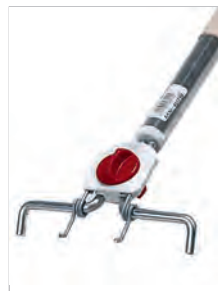

Tool handles 4-hole patented system

Item No.	Item	Size
650800	aluminium stick, patented	1,50 m
650801	wooden stick, patented	1,50 m



Dustpans and brushes

Item No.	Item
A 650900	plastic pan with rubber lip
B 651000	sheet pan with rubber lip
C 651100	hand broom, hair mixture
E 651200	hand broom, coconut fibre
D 651201	hand broom, nylon, plastic body, food-safe

Brushes & Brooms



Dustpan and broom Item No. 650901
blue with rubber lip, snap-on broom



Stand-up dust-pan with broom
Item No. 459280
grey, deluxe



Sanitary brushes

Item No.	Item	Size
A 650001	nylon, plastic body, 4-hole patented system	30 cm
650101	nylon, plastic body, 4-hole patented system	40 cm
B 650352	general purpose brush, plastic, white, 8-shaped	
C 650353	general purpose brush, PP, pointed-round	18 cm
D 651201	hand broom, nylon, plastic body	



Floor and ceiling brush

Item No.	Item	Size
653600	extendible, oval	1,50 m
459290	mountable on telescopic handle	



Heater brush Item No. 652700
U-shaped, length: 35 cm



Feather duster

Item No.	Item	Size
A 456204	telescopic feather duster lambskin	70-110 cm
B 456207	duster stick with microfibre cover	90 cm
456206	microfibre cover replacement	50x10 cm

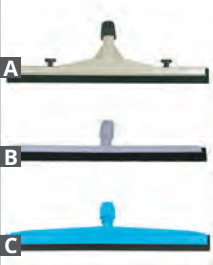

Water pusher
plastic, with foam rubber

Item No.	Item	Size
A 401049	foam rubber exchangeable , grey	45 cm
A 401050	foam rubber exchangeable , grey	55 cm
A 401047	foam rubber exchangeable , grey	75 cm
B 659500	"extra strong", grey	35 cm
B 659501	"extra strong", blue	35 cm
C 659700	"extra strong", blue	45 cm
C 659800	"extra strong", blue	55 cm
C 659900	"extra strong", blue	75 cm

Accessories

401048	replacement for foam rubber pusher, 45 cm
401051	replacement for foam rubber pusher, 55 cm
401054	replacement for foam rubber pusher, 75 cm

Other Equipment

Gloves		
Item No.	Item	Size
B 651801	neoprene, chemical-resistant, CE-certified, pair	L, XL
A 653000	rubber, food-safe, yellow, pair	S, M, L, XL
C 653020	disposable gloves, vinyl, transparent, powdered, 100 Stk.	M, L
D 653040	disposable gloves, nitrile, blue, powder-free, 100 Stk.	M
653041	disposable gloves, nitrile, blue, powder-free, 100 Stk.	L
E 620004	microfibre gloves, neon-green	uni

Latex gloves		
blue rubber glove, 1-A quality, natural latex, food-safe, cotton flocked inside, tearproof, with a secure grip, 40 boxes/palette		
Item No.	Item	Size
653006	box with 144 pcs.	M
653007	box with 144 pcs.	L
653008	box with 144 pcs.	S

Fork mop		Item No. 653700
synthetic, 45 cm		

Danger signs		
Item No.	Item	Size
463700	with label "Achtung Rutschgefahr" (Attention wet floor), threepart	ca. 97cm
463701	with label "Achtung Rutschgefahr" (Attention wet floor), twopart	ca. 57cm
463703	neutral, twopart, with symbol	ca. 57cm
463704	neutral, threepart, with symbol	ca. 97cm
463706	neutral, twopart	ca. 57cm
463707	neutral, threepart	ca. 97cm

Spray can		
1,5 l, various spray attachments for different bottles available		
Item No.	Item	Size
565101	with force pump	1,5 l
565103	for acid cleaners	1,5 l
565104	for alcalic cleaners	1,5 l

Doormats		
Polyester fibre with rubber back, in colours black-white, black-red oder black-blue		
Item No.	Item	Size
465700	mat	40x60 cm
465750	mat	60x90 cm
465800	mat	90x150 cm
465802	roll, black-white	1,20x20 m
465900	mat	120x180 cm

Metal scraper		Item No. 651800
extra strong, width: 5 cm		

Waste picker		Item No. 402160
Waster/paper picker to pick up from the floor		

Hygienic Paper & Dispensers



Paper towel dispenser
Item No. 654100
metal with lock, 27x33x13 cm



Paper towel dispenser Lorito
Item No. 654147
plastic for C/VL-fold, 27,5x28x13 cm



Jumbo paper roll mount
Item No. 633460
white, metal with hex-wrench



Hygienic pouches and dispenser

Item No.	Item
654400	hygienic pouches, eco-paper, 28x12x5 cm
654410	hygienic pouch dispenser



Hygienic paper

Item No.	Item	Type	Size
633520	jumbo paper	two-ply, on roll	360 m
653512	toilet paper Lorito Soft	two-ply, 250 sheets	
653511	toilet paper Lorito Flauschi	three-ply, 250 sheets	
653540	toilet paper frisch+sauber	recycled, 2-lagig, 250 sheets	
654130	paper towel	natural, quire fold, single ply, 3640 sheets	25x33 cm
654140	cleansing tissue	two-ply, 100 pcs. per box	
654200	paper towel Lorito	natural, ZZ/V fold, single ply	25x21 cm
654213	paper towel Lorito	natural, ZZ/V, cellulose, 1A, two-ply	25x21 cm
10369020	kitchen roll	two-ply, 4x51 sheets	



Urinal Deodorizer

Item No.	Item
652605	Tutti-Frutti
652606	Apple
652607	Mango
652614	Ocean



Air Freshener Dispenser

Item No.	Item
652608	Apple
652609	Tutti-Frutti
652611	Mango
652615	Ocean



Papier bin Item No. 654300
white, foldable, sintered, 40x23x64 cm



Air Freshener Curve
with holder

Item No.	Item
652625	Citrus
652623	Cotton Blossom
652624	Fabulous
652622	Herbal Mint
652621	Mango

Soap Dispensers



Soap dispenser
plastic

Item No.	Size
626720	1000 ml
626770	500 ml



Foam soap dispenser
cylindric, 250 ml, 18x6,5 cm, in different colours

Item No.	Item
626000	white
626001	black
626002	red
626003	bramble
626004	aqua



Soap dispenser Item No. 627000
with special steel force pump and cover, lockable, 1000 ml



Soap dispenser Lorito
Item No. 626820
plastic, without cover, for cream soap, refillable, lockable, 1000 ml



Foam dispenser Lorito
Item No. 626705
special steel/plastic parts and pump, 500 ml

Accessories	
126706	"Lori Foam" foam soap, 5 l



Foam soap dispenser with foaming unit Item No. 625000
plastic, 550 ml



Cartridges for soap dispenser

Item No.	Item	Size
326800	soap dispenser cartridge for CWS	500 ml
326802	soap dispenser cartridge for Apura	750 ml
326803	soap dispenser cartridge for Tork and Mölntyke (old)	1000 ml
326804	soap dispenser cartridge for CWS	400 ml
326900	soap dispenser cartridge for CWS	950 ml



Rioloto peach soap Item No. 430700
in pump dispenser, 500 ml

Other Accessories



Toilet brush

Item No.	Item
650358	urinal brush
652500	toilet set
652515	toilet brush, plastic



Waste bin

chromed with plastic inlay

Item No.	Item
60011	Treteimer 13 Liter
60021	Treteimer 3 Liter



Pumie scouring stick

performs, where chemicals are useless!

Item No.	Item
652516	Pumie Stick with handle
652517	Pumie Stick



Funnel tube 150 cm

Item No. 464211

suitable for almost all water-tap, put plastic nozzle over the tap ... and ready!



HERWE Cura Skin care creme

Item No. 10191

White, mild greasing and quickly absorbed creme with bees wax, without silicones. Tube, 100 m



Socket cleaning brush

Item No.	Item
650362	socket cleaning brush
650363	socket cleaning brush "combi"



Fuginal Fuginator joint brush

Item No. 650364

Fuginator cleans all mineral elastic joint seal and removes dirt easily from any joint. Ergonomic grip, effective working.



Waste-paper baskets

Item No. 61069

18 l

Cleaning & Hotel Trolleys

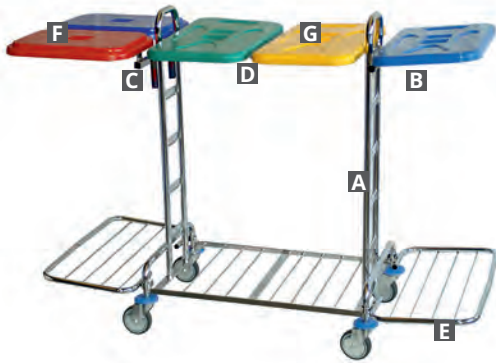

Serie 105 waste trolley Item No. 46105

holding frame: 1x120 l, 2x120 l, 2x70 l & for one trough; grate shelf, plastic cover 70 l, clip for plastic bag.

Accessories

- | | | |
|---|--------|---|
| A | 46200 | base frame incl. 2 equipment frames, 52x82 cm |
| B | 46205 | holding frame sideways, 1x120 l |
| | 46206 | holding frame sideways, strengthened, 2x120 l |
| D | 46207 | holding frame, centred, 2x120 l |
| C | 46208 | holding frame sideways, 2x70 l |
| E | 46209 | grate shelf |
| | 46216 | gabion cage, lockable |
| F | 46221 | plastic cover, 70 l |
| G | 46222 | plastic cover (red, blue, green, yellow), 120 l |
| | 464210 | stick holder with snap fit, Ø 22 mm |
| | 464212 | broom holder with snap fit, Ø 22 mm |
| | 464215 | stick holder, adjustable clip-flip |
| | 464606 | grate shelf with roll |
| | 468260 | mounting clip for plastic bags |



Serie 106 Item No. 46106

base frame, equipment frame, rack for bucket, holding frame 120 l sideways and for trough, grate shelf, trough small and holding frame (central), clips for plastic bag, plastic press, plastic bucket 17 l in red, blue.

Accessories

- | | | |
|---|--------|---|
| A | 46200 | base frame incl. 2 equipment frames, 52x82 cm |
| | 46204 | rack for 2x17 l buckets |
| B | 46205 | holding frame sideways, 1x120 l |
| | 46206 | holding frame sideways, strengthened, 2x120 l |
| | 46208 | holding frame sideways, 2x70 l |
| C | 46209 | grate shelf |
| D | 46211 | plastic trough small, 45x26x8 cm |
| | 46216 | gabion cage, lockable |
| | 46218 | holding frame for plastic trough small |
| | 46221 | plastic cover, 70 l |
| | 46222 | plastic cover (red, blue, green, yellow), 120 l |
| E | 460000 | plastic bucket, rectangular, (red, blue), 17 l |
| | 463642 | bucket grid (sieve) |
| | 464210 | stick holder with snap fit, Ø 22 mm |
| | 464212 | broom holder with snap fit, Ø 22 mm |
| | 464215 | stick holder, adjustable clip-flip |
| | 464503 | mount for toilet paper rolls |
| | 464606 | grate shelf with roll |
| | 468260 | clip to mount the plastic bags |
| F | 468400 | plastic press |



Serie 107 Item No. 46107

base frame, equipment frame, gabion cage, press mount, holding frame 120 l sideways for trough, grate shelf, clips for plastic bag, plastic press, plastic bucket 6 l in red, blue, yellow, plastic bucket 17 l in red, blue.

Accessories

- | | | |
|---|--------|--|
| A | 46200 | base frame incl. 2 equipment frames, 52x82 cm |
| B | 46202 | gabion cage, 62x23x13 cm |
| C | 46203 | press mount |
| D | 46205 | holding frame sideways, 1x120 l |
| | 46206 | holding frame sideways, strengthened, 2x120 l |
| | 46208 | holding frame sideways, 2x70 l |
| E | 46209 | grate shelf |
| | 46216 | gabion cage, lockable |
| | 46221 | plastic cover, 2x70 l |
| | 46222 | plastic cover (red, blue, green, yellow), 120 l |
| F | 459400 | plastic bucket, rectangular, (red, blue, yellow, green), 6 l |
| G | 460000 | plastic bucket, rectangular, 17 l |
| | 464210 | stick holder with snap fit, Ø 22 mm |
| | 464212 | broom holder with snap fit, Ø 22 mm |
| | 464215 | stick holder, adjustable clip-flip |
| | 464503 | mount for toilet paper rolls |
| | 464606 | grate shelf with roll |
| | 468260 | clip to mount the plastic bags |
| H | 468400 | plastic press |

Cleaning & Hotel Trolleys

**Serie 108** Item No. 46108

base frame, equipment frame, holding frame 1x120 l, sideways u. holding frame for trough, grate shelf, holding frame and plastic trough large, bucket holder 2x6 l, disinfectant trough and bucket grid, clips for plastic bag, plastic bucket 6 l in red, blue, yellow, green.

Accessories

- | | | |
|---|--------|--|
| A | 46200 | base frame incl. 2 equipment frame, 52x82 cm |
| B | 46202 | gabion cage, 62x23x13 cm |
| C | 46205 | holding frame sideways, 1x120 l |
| | 46206 | holding frame sideways, strengthened, 2x120 l |
| | 46208 | holding frame sideways, 2x70 l |
| D | 46209 | grate shelf |
| | 46212 | holding frame for plastic trough large |
| | 46216 | gabion cage, lockable |
| | 46220 | bucket holder, 2x6 l |
| | 46221 | plastic cover, 2x70 l |
| | 46222 | plastic cover (red, blue, green, yellow), 120 l |
| E | 459400 | plastic bucket, rectangular, (red, blue, yellow, green), 6 l |
| | 463642 | bucket grid (sieve) |
| | 464210 | stick holder with snap fit, Ø 22 mm |
| | 464212 | broom holder with snap fit, Ø 22 mm |
| | 464215 | stick holder, adjustable clip-flip |
| | 464503 | mount for toilet paper rolls |
| | 464606 | grate shelf with roll |
| F | 464641 | disinfectant trough, 45 l |
| G | 468250 | plastic trough big, 60x48x8cm |
| | 468260 | clip to mount the plastic bags |

**Serie 203** Item No. 450203

base frame, 2 rolls 180 mm and rack for clip holder, equipment frame, plastic trough and holding frame, grate shelf, holding frame for plastic bag 120 l, bottle rack, stick holder, adjustable clip-flip, clip for plastic bag, plastic press, plastic bucket 6 l in red, blue, plastic bucket 17 l in red.

Accessories

- | | | |
|---|--------|---|
| A | 46211 | plastic trough, 47x26x8 cm |
| B | 451200 | base frame Serie 203 (incl. 2 rolls 100 mm, 2 rolls 180 mm and rack for clip mount, rectangular bucket, red, blue, 6 l) |
| C | 451201 | equipment frame, height: 98 cm |
| D | 451202 | grate shelf |
| E | 451203 | holding frame for plastic bag (short mount), 120 l |
| | 451204 | holding frame for trough (long mount) |
| | 451205 | bottle rack |
| | 451206 | holding frame 2x70 l |
| | 451207 | holding frame 2x120 l |
| F | 459400 | plastic bucket, rectangular, (red, blue, yellow, green), 6 l |
| G | 460000 | plastic bucket, rectangular, (red, blue), 17 l |
| H | 464215 | stick holder, adjustable clip-flip |
| | 468260 | clip for plastic bag |
| I | 468400 | plastic press |

**Serie 204** Item No. 450204

base frame Serie 204, equipment frame, press mount, plastic trough u. holding frame, holding frame for plastic bag 120 l, bottle rack, stick holder adjustable clip-flip, clip for plastic bag, plastic press, plastic bucket 6 l in red, blue, plastic bucket 17 l in red, blue.

Accessories

- | | | |
|---|--------|--|
| A | 46211 | plastic trough, 47x26x8cm |
| B | 451203 | holding frame for plastic bag (short mount), 120 l |
| | 451204 | holding frame for trough (long mount) |
| | 451205 | bottle rack |
| | 451206 | holding frame 2x70 l |
| | 451207 | holding frame 2x120 l |
| C | 451208 | base frame Serie 204, incl. 4 rolls 100 mm |
| D | 451209 | equipment frame, height: 96 cm |
| | 451210 | press mount |
| E | 459400 | plastic bucket, rectangular, (red, blue), 6 l |
| F | 460000 | plastic bucket, rectangular, (red, blue), 17 l |
| G | 464215 | stick holder, adjustable clip-flip |
| | 468260 | clip for plastic bag |
| H | 468400 | plastic press |

Cleaning & Hotel Trolleys



System trolley "Willy" Item No. 459248

multifunctional, highly customisable plastic system trolley for the cleaning and housekeeping sector.

Accessories

OE 4010201	base plate large
OE 4010202	cover plate large
OE 4010203	base plate small
OE 4010204	cover plate small
OE 4010205	mounting frames
OE 4010206	sack holding frame, 120 l
OE 4010207	mount for sack holding frame
OE 4010208	cover for 120 l holding frame (red, blue, yellow, green)
OE 4010209	plastic bucket, rectangular (handle red, blue, yellow, green), 8 l
OE 4010211	sack holding frame (red, blue), 60 & 120 l
OE 4010212	plastic trough for mop rack
OE 4010213	extension for sack holding frame to 2x70 l
OE 4010214	rail for plastic trough
OE 4010215	mop rack
OE 4010216	stick holder
OE 4010220	hook for equipment
OE 4010222	clip holder for hook/stick holder
OE 4010223	plug holder for hook/stick holder
OE 4010225	plastic press
OE 4010227	handle
OE 4010237	side panel
OE 4010234	door lock
OE 4010238	door left/right
OE 4010241	storage container, rectangular (grey), 20 l
OE 4020003	press mount
OE 4020001	roll 100 mm, without brake
OE 4020002	roll 100 mm, with brake
OE 4020005	roll 150 mm, without brake
OE 4020006	roll 150 mm, with brake
OE 4000007	plastic bucket, rectangular (red, blue), 20 l
OE 4072005k	laundry bag, 120 l, red



Cleaning trolley "Max" Item No. 48201

high-quality, coated with Rilsan® (high-performance polymere produced from natural raw material). Equipped with 2 mounting frames, plastic buckets 12 l in red, blue, plastic buckets 17 l in red, blue, press mount, plastic press, adjustable stick holder, sack holding frame, grate shelf, 2 plastic troughs (grey)

Accessories

A	482000	base frame, 53x85cm
B	4860000	plastic bucket, rectangular, red, blue, 17 l
C	459300	plastic bucket, rectangular, red, blue, 12 l
D	482006	press mount
E	468400	plastic press
	464215	stick holder, adjustable
	466010	sack holding frame, 120 l
F	482001	mounting frame
G	482003	grate shelf, plastic
H	482005	plastic trough



Hotel trolley Item No. 459246

plastic, with door, measures (hxxwx): 130x160x57 cm

4 grey rubber rolls Ø 20 cm, thereof two flexible with brakes, 2 fabric-reinforced laundry bags 85 l with zip, 3 shelves 77x46 cm, 1 upper storage rack 77x47 cm, several mounts for equipment, edge protection (4 flexible rolls).



Housekeeping trolley "Thommy", "Thommy Duo"

holding frame with integrated storage rack, cover, handles, hooks. Multifunctional mounts for equipment. With shelf, fabric-reinforced laundry bag (65 l) with zip, grey rubber rolls, thereof two flexible rolls.

Item No. Item

- 459275 Thommy, 70 l
- 459276 Thommy Duo, 2x70 l
- 459277 Thommy 2x25l with press

Accessories

- 401001 plastic bucket combi, red, 6 l
- 401002 plastic bucket combi, yellow, 6 l
- 401003 plastic bucket combi, blue, 6 l
- 401004 plastic bucket combi, green, 6 l
- 401005 plastic bucket combi, blue, 25 l
- 401006 plastic bucket combi, red, 25 l
- 457810 bucket (red, yellow, blue, green), 4 l
- 460000 plastic bucket, red, blue, 17 l



Housekeeping trolley "Elegance" Item No. 469000

high-quality, coated with Rilsan® (high-performance polymere produced from natural raw material). This trolley is used in many 5-star hotels!

Measures (LxWxH): 178x56x127 cm, with storage rack: 178x56x142 cm

With plastic storage rack, 2 grey fabric-reinforced laundry bags (120 l), 1 door stopper, 8 edge protection discs

Cleaning & Hotel Trolleys



Waste trolley x-formed

with Ø 100 mm rolls.

Item No. Item

464500	chromed holding frame without mounts
464501	complete with 1x120 l chromed holding frame
464502	complete with 2x120 l chromed holding frame
463800	galvanised holding frame without mounts
463801	complete with 1x120 l galvanised frame
463802	complete with 2x120 l galvanised frame

Accessories

462200	galvanised storage grate, sideways
462900	galvanised holding frame sideways, 1x120 l
462901	cover for holding frame 1x120 l, centered
463500	galvanised holding frame tandem, centered, 2x120 l
464000	box sack polypropylene, with loops, 140 l, 48x48x88 cm
464200	stick holder for one stick, plastic
464310	panel with pocket, 3-rowed, 10 pockets
464600	chromed holding frame for 1x120 l plastic bag
457700	rectangular bucket, plastic, red, 12 l
468100	metal basket, plastic-coated, 42x21x21 cm



Laundry trolley „Steve“

Item No. 459320

measures: 90 x 66 x 86 cm, laundry bag, ca. 220 l

Accessories

459321	laundry bag, ca. 220 l
--------	------------------------

Vacuum Cleaners



Lorito Silent 10 / 15

Power:	1200 W	Hose length:	2,5 m
Air flow:	35 l/sec	Weight:	7 kg / 8 kg
Tank capacity:	10 l / 15 l	Sound level:	59 dB
Cable length:	10 m		



Webcode: #pef8

Equipment

flexible hose with intake manifold and false air regulator, combination floor tool, crevice nozzle, radiator brush, two-parted stainless steel tube, 1 paper filter.

Item No. Item

491000	Silent 10
491510	Silent 15

Accessories

481029	aluminium telescopic tube
--------	---------------------------



Lorito Profi Item No. 443500

Power:	1200 W	Hose length:	2,5 m
Container capacity:	10 l	Weight:	6,3 kg
Water level:	2700 mm	Sound level:	ca. 64 dB
Cable length:	15 m		



Webcode: #kp7y

Equipment

flexible hose with intake manifold and false air regulator, combination floor tool, crevice nozzle, radiator brush

Accessories

481029	aluminium telescopic tube
--------	---------------------------



Hitachi CV-300, CV-300 P

single-level turbo compressor, safety automatic

Power:	1300 W	Hose length:	3 m
Container capacity:	7,5 l	Weight:	4,5 kg
Cable length:	12 m	Sound level:	63 dB



Webcode: #igtY

Equipment

hardened vinyl tube with bented extension, 3 extension tubes, combination floor tool, crevice nozzle, all-purpose brush, HEPA-filter.

Item No. Item

448103	CV-300
448104	CV-300 P

Type

with fabric filter
with 2 paper filter at 4,5 l



Hitachi CV-400 Item No. 448105

well-ried for over 40 years, robust plastic case, energy-saving engine. Available colours: blue, green, orange, pink.

Power:	900 W	Hose length:	3 m
Tank capacity:	7,5 l	Weight:	4 kg
Cable length:	10 m	Sound level:	73 dB



Webcode: #wt1h

Equipment

hardened vinyl tube with bented extension, 3 metal extension tubes, combination floor tool, crevice nozzle, all-purpose brush.

Vacuum Cleaners

**Hitachi CV-940** Item No. 449000

turbine with 33.500 turns/min, blow gun

Power:	1600 W	Hose length:	2 m
Tank capacity:	18 l	Weight:	6,2 kg
Cable length:	12 m	Sound level:	64 dB



Webcode: #ghvz

Equipment

hardened vinyl tube with bented extension, 2 metal extension tubes, combination floor tool, crevice nozzle, all-purpose brush.

**Lorito Baby** Item No. 491520

Power:	1200 W	Weight:	7 kg
Tank capacity:	7 l	Sound level:	55 dB
Cable length:	10 m		

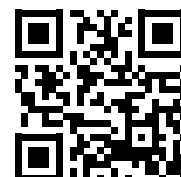

Webcode: #6g4d

**Cleanfix S10 Plus** Item No. 022010

vacuum 250 mbar, 5 rolls, measures (LxWxH): 40x40x49 cm

Power:	1100 W	Weight:	7 kg
Tank capacity:	9 l	Sound level:	62 dB
Bag capacity:	6 l	Cable length:	10 m

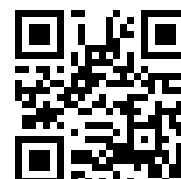

Webcode: #2uqa

Hint

**Save expenses!**

We operate repairs and safety-related checks in our electro-workshop for your single-disc-machines, Cleanfix-machines, Duplex-carpet-cleaning-machines, spray-extraction-machines, power-sweeper, dry and wet cleaners as well as industry cleaners according to DIN DIN VDE 0701 / 0702!

If you have any question, please contact us under:

Tel.: +49 (0) 9176 / 9805-0

E-Mail: info@oehme-lorito.de

Wet and Dry Cleaners



Lorito SW 38 Item No. 448031

Power:	1000 W	Cable length:	10 m
Tank capacity:	38 l	Hose length:	2,6 m
Water capacity:	23 l	Weight:	13 kg
Water level:	2000 mm		

Equipment
suction hose 2,60 m, metal tube two-parted, combination floor tool, crevice nozzle, all-purpose brush, vacumat nozzle.

Accessories
BF866 fleece filter bag



Webcode: #7ual



SW 93 Item No. 448071

two-level motor, diameter for accessories: 38 mm

Power:	2x1000 W	Cable length:	10 m
Tank capacity:	73 l	Hose length:	2,6 m
Water level:	2000 mm	Weight:	27 kg (complete)

Equipment
suction hose, 2,60 m, metal tube two-parted, combination floor tool, crevice nozzle, all-purpose brush, vacumat nozzle.



Webcode: #6j7q



SW 30 Cleanair Item No. 446710

with by-pass cooling

Power:	1000 W	Cable length:	10 m
Tank capacity:	30 l	Hose length:	2,7 m
Water level:	2200 mm	Weight:	10 kg

Equipment
hardened suction hose, extension tubes, combination floor tool, vacumat nozzle, suction tube, radiator brush.



Webcode: #2rp7



SW 55 Cleanair Item No. 446850

with by-pass cooling

Power:	1000 W	Cable length:	10 m
Tank capacity:	55 l	Hose length:	2,7 m
Water level:	2200 mm	Weight:	22 kg

Equipment
hardened suction hose, extension tubes, combination floor tool, vacumat nozzle, crevice nozzle, radiator brush.

Accessories
447800 suction cart 65 cm, with hose
447801 suction cart 75 cm, with hose

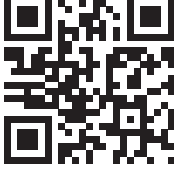

Webcode: #hmuw

Wet and Dry Cleaners

**SW 75 Cleanair** Item No. 447210

with by-pass cooling

Power:	3x1000 W	Cable length:	10 m
Tank capacity:	75 l	Hose length:	2,7 m
Water level:	2600 mm	Weight:	31 kg



Webcode: #hwwa

Equipment

hardened suction hose, extension tubes, combination floor tool, vacumat nozzle, crevice nozzle, radiator brush.

Accessories

447600	suction for rough dirt
447800	suction cart 65 cm with hose
447801	suction cart 75 cm with hose

**BF 584 A-3 with suction cart** Item No. 448090

diameter for accessories: 40 mm

Power:	3x1000 W	Hose length:	2,6 m
Tank capacity:	105 l	Working width:	65 cm
Water capacity:	75 l	LxWxH:	44x44x95 cm
Water level:	3000 mm	Weight:	30 kg
Cable length:	7,2 m		



Webcode: #b45v

Equipment

suction cart, working width 65 cm, suction hose 2,6 m, chromed metal tube two-parted, combination floor tool, vacumat nozzle, crevice nozzle, all-purpose brush.

Upright Vacuum Cleaners



SEBO 36 Comfort Item No. 900370

Power vacuum motor:	1300 W	Cable length:	12 m
Power Brush motor:	175 W	Hose length:	0,25 m (Stretch)
Tank volume:	5 l	Working width:	36 cm
Water level:	2350 mm	Weight:	7,9 kg

Equipment

telescopic hose with suction lance



Webcode: #541t



SEBO 46 Comfort Item No. 900470

Power Vacuum motor:	1300 W	Cable length:	12 m
Power Brush motor:	200 W	Hose length:	0,25 m (Stretch)
Tank volume:	5 l	Working width:	46 cm
Water level:	2350 mm	Weight:	8,5 kg

Equipment

telescopic hose with suction lance



Webcode: #3v6y



Ruck Zuck knapsack exhauster Item No. 446010

Power:	1350 W	Hose length:	1,1 m
Tank volume:	3,5 l	Weight:	4,8 kg
Cable length:	15 m		

Equipment

suction hose with bent and false air regulator, telescopic tube, extension tube, combination floor tool, crevice nozzle, all-purpose brush, radiator brush, 1 paper filter.



Webcode: #em6x

Accessories for Vacuum Cleaners

Combination floor tool

Item No. 929294
black, adjustable, working width: 290 mm, tube diameter: 35 mm

**Combination floor tool**

Item No. 914800
black, adjustable, working width: 270 mm, tube diameter: 32 - 37 mm adjustable

**Combination floor tools**

grey, adjustable, working width: 300 mm

Item No.	Item
B 7790915	diameter, suitable for Hitachi
A 929293	Hitachi, diameter: 32 mm

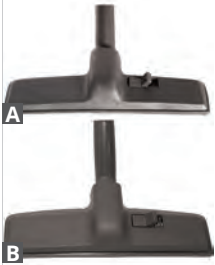
**Turbo nozzle** Item No. 914700

black, adjustable, working width: 250 mm, tube diameter: 32 mm

**Combination floor tool for parquet**

working width 300 mm, tube diameter: 32 mm

Item No.	Item
A 929299	hair mixture
B 929300	PP brush strips

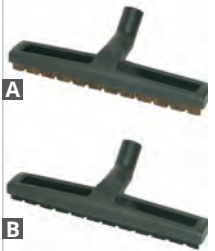
**Adapter for Hitachi nozzle**

for vacuum cleaners with different tube diameters

Item No.	Item
B 7790923	diameter: 35 mm
A 7790924	diameter: 32 mm

**Crevice nozzle** Item No. 700035

black, diameter suitable for Hitachi

**All-purpose brush** Item No. 700098

fixed, black, suitable for Hitachi

**Hose set complete**

Item No. 777777
fixed, black, suitable for Hitachi



Accessories Vacuum Cleaners

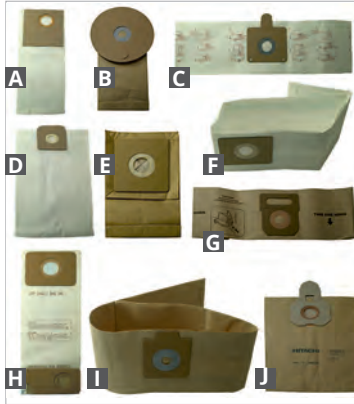

Paper filters

Item No.	Item
A 443301	for Lorito BS37/47
B 443315	for knapsack exhauster Free Vac 2,5
C 446505	for Lorito S11 old/new, Compacto 6, Compacto 9
D 480001	for vacuum cleaner OTTO 1210
E 490030	for vacuum cleaner OTTO 821
F 491010	for Lorito Silent 10
F 491015	for Lorito Silent 15
G 643533	for Lorito Profi
H 900000	combi, 2-layered for all BS and SEBO
I 920000	for GS 20 de Luxe
J 7318202	for Hitachi CV 200P/CV 300P
447021	for Rabbit Blue



Power cable

unpluggable, 2-pin, red, with Schuko plug and rubber connector

Item No.	Item
481053	15 m, red, angle plug
970005	15 m, red, straight plug



Tubes for vacuum cleaners

Item No.	Item	Size
A 481029	telescopic tube	56-94 cm
B 970034	telescopic tube, 32mm	50-80 cm
C 7790922	extension tube suitable for Hitachi	44 cm

Single Disc Machines

**BF 521** Item No. 669414

Planetary gear

Power:	1200 W	Cable length:	12 m
Revolution:	154 min ⁻¹	Working width:	43 cm
Tank volume:	12 l	Weight:	36,8 kg (complete)

Equipment

Driving disk, shampooing brush, washing brush, lye tank

Accessories

668445	driving disk
668446	shampooing brush
668447	washing brush
668448	lye tank



Webcode: #tbke

**C 143 L10** Item No. 669420

Planetary gear

Power:	1000 W	Working width:	43 cm
Revolution:	154 min ⁻¹	Weight:	41 kg
Cable length:	12 m		

Accessories

617307	lye tank, 12 l
668446	shampooing brush
668447	washing brush
669402	driving disk



Webcode: #dz7b

**C 143 TSN two speed** Item No. 618502

Planetary gear

Power:	1000 W / 1300 W	Working width:	43 cm
Revolution:	154 min ⁻¹ / 308 min ⁻¹	LxWxH:	54,2x42,5x120 cm
Working pressure:	41,8 g/cm ²	Weight:	42,5 kg
Cable length:	15 m		

Equipment

Driving disk

Accessories

617307	lye tank, 12 l
668446	shampooing brush
668447	washing brush



Webcode: #r2gp

**C 150 U 13 (polishing machine)** Item No. 681505

Power:	1500 W	Working width:	50,5 cm
Revolution:	1500 min ⁻¹	Weight:	44 kg
Working pressure:	variable	Sound level:	56 dB
Cable length:	15 m		

Equipment

Driving disk

Accessories

00-256EL	electric spray tool with tank
----------	-------------------------------



Webcode: #fwal

Single Disc Machines

**C 150 L 16** Item No. 618211

Planetary gear

Power: 1600 W
 Revolution: 154 min⁻¹
 Cable length: 15 m

Working width: 50,5 cm
 Weight: 49 kg



Webcode: #kmus

Accessories

617307 lye tank, 12 l
 618202 driving disk
 618206 shampooing brush
 618203 washing brush, PPN 0,7mm
 618204 polishing brush Union Natur
 618205 tynex brush (grinding) grit 1,2mm

**HS 2000** Item No. 670010

Belt drive

Power: 1100 W
 Revolution: 2000 min⁻¹
 Cable length: 15 m

Working width: 51 cm
 Weight: 35 kg



Webcode: #df6u

Accessories

619400 suction, 1207 white/blue, unmounted

**Lympia 13** Item No. 617201

Planetary gear

Power: 500 W
 Revolution: 188 min⁻¹
 Cable length: 10 m

Working width: 33 cm
 Weight: 22 kg



Webcode: #mn8j

Accessories

617202 driving disk with foam rubber and pad holder
 617203 washing brush, PPN 0,7mm
 617204 polishing brush Union Nature
 617205 shampooing brush, PPN 0,3mm
 617206 tynex brush (grinding) grit 1,2mm
 617207 lye tank, 9 l

**BF 520** Item No. 669541

Planetary gear

Power: 750 W
 Revolution: 190 min⁻¹
 Tank volume: 8 l

Cable length: 12 m
 Working width: 33 cm
 Weight: 25 kg (complete)



Webcode: #1voa

Equipment

Lye tank, driving disk, shampooing brush, washing brush.

Spray Extraction Machines



Sabrina Item No. 438403

Power vacuum motor: 1000 W
 Power regulator: 2 levels
 Sewage tank volume: 14 l
 Cleaning solution volume: 14 l

Water level: 2200 mm
 Cable length: 10 m
 Working width: 27 cm
 Weight: 12 kg



Webcode: #9pea

Accessories

NS10ALL all-purpose tool



Sabrina maxi Item No. 438404

Power vacuum motor: 1200 W
 Power regulator: 3 levels
 Sewage tank volume: 30 l
 Cleaning solution volume: 30 l

Water level: 2300 mm
 Cable length: 10 m
 Working width: 30 cm
 Weight: 22 kg



Webcode: #7qiu

Accessories

NS10ALL all-purpose tool



Spray extraction machine Profi Item No. 438407

Power vacuum motor: 1200 W
 Pump power: 40 W
 Max. pressure: 29 PSI (1,99 bar)
 Fresh water volume: 9 l

Sewage tank volume: 7 l
 Cable length: 7 m
 Weight: 12,85 kg (complete)
 Sound volume: 65 dB



Webcode: #m6ls

Equipment

1 floore toole, 235 mm working width, 1 all-purpose tool, 90 mm working width

Scrubber Dryers



Two-roll cleaning machine

Power:	750 + 26 W	Sewage tank volume:	1,7 l
Revolution:	650 min ⁻¹	Cable length:	10m
Max. ground coverage:	550 m ² /h	Weight:	25 kg
Fresh water volume:	4 l		

Item No.	Item
980000	Working width: 34 cm
970000	Working width: 44 cm



Webcode: #53v4



RA 300 E

Item No. 668400
with 2 disc brushes

Voltage:	12 V DC	Fresh water volume:	12 l
Power vacuum motor:	300 W	Sewage tank volume:	11 l
Power brush motor:	150 W	Working width:	33 cm
Revolution:	240 min ⁻¹	Accu capacity:	25 Ah
Pressure:	17 kg	Weight:	35 kg (with accu)



Webcode: #gg32



RA 431 E

Item No. 436713

Voltage:	230 V AC	Fresh water volume:	35 l
Gear power:	1100 W	Sewage tank volume:	40 l
Power vacuum motor:	750 W	Working width:	43 cm
Revolution:	180 min ⁻¹	Cable length:	20 m
Pressure:	34 kg	Weight:	62 kg (complete)



Webcode: #8e92



RA 431 B

Item No. 436712

Voltage:	12 V DC	Fresh water volume:	32 l
Gear power:	750 W	Sewage tank volume:	38 l
Power vacuum motor:	400 W	Working width:	43 cm
Revolution:	135 min ⁻¹	Weight:	122 kg (without accu)
Pressure:	54 kg		



Webcode: #fwgz



RA 501 E

Item No. 501000

Voltage:	230 V AC	Fresh water volume:	35 l
Gear power:	1100 W	Sewage tank volume:	40 l
Power vacuum motor:	750 W	Working width:	50 cm
Revolution:	180 min ⁻¹	Cable length:	20 m
Pressure:	34 kg	Weight:	62 kg (complete)

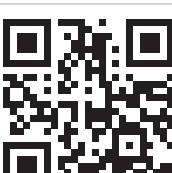

Webcode: #nx7x



RA 501 B

Item No. 501010

Voltage:	12 V DC	Fresh water volume:	32 l
Gear power:	1000 W	Sewage tank volume:	38 l
Power vacuum motor:	400 W	Working width:	50 cm
Revolution:	135 min ⁻¹	Cable length:	20 m
Pressure:	48 kg	Weight:	122 kg (without accu)

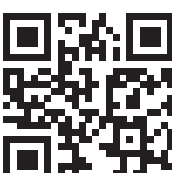

Webcode: #fp84

Scrubber Dryers



RA 605 IBCT Item No. 565055

Voltage: 24 V DC
 Gear power: 750 W
 Power vacuum motor: 400 W
 Revolution: 218 min⁻¹
 Pressure: 55 kg

Fresh water volume: 55 l
 Sewage tank volume: 56 l
 Working width: 62 cm
 Suction width: 88 cm
 Weight: 190 kg (without accu)



Webcode: #ig6k



Minispeed 350 E Item No. 636370

compact, foldable construction, easy transportation, fits in every trunk/boot. Automatic disc replacement. Multifunctional with different scrubbing and polishing discs. With 1 brush.

Voltage: 230 V AC
 Gear power: 750 W
 Power vacuum motor: 880 W
 Pressure: 25 kg
 Water level: 1950 mm

Fresh water volume: 13 l
 Sewage tank volume: 16 l
 Working width: 350 cm
 Suction width: 500 cm
 Weight: 38 kg (empty)



Webcode: #gmpi



Minispeed 350 B Item No. 636360

compact, foldable construction, easy transportation, fits in every trunk/boot. Automatic disc replacement. Multifunctional with different scrubbing and polishing discs. With 1 brush. Batteries: 2x 12V / 18 AH, 60 minutes battery life.

Voltage: 24 V DC
 Gear power: 200 W
 Power vacuum motor: 350 W
 Pressure: 25 kg
 Water level: 1100 mm

Fresh water volume: 13 l
 Sewage tank volume: 16 l
 Working width: 350 cm
 Suction width: 500 cm
 Weight: 38 kg (without accu)

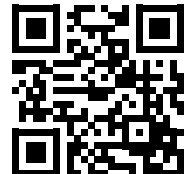

Webcode: #gmpi

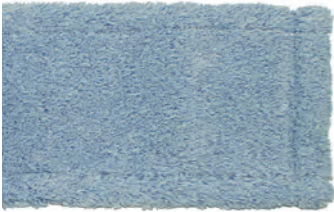
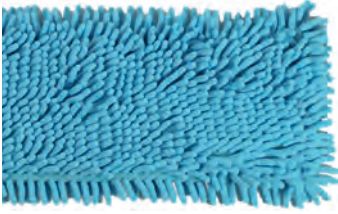

Microfibre

Microfibres are very thin and soft, but even steady and tear-resistant fibres. These specifications allow an wide area of operations: microfibre textiles are suitable for wiping and polishing as well as for dedusting.

Because of the enormous fineness, that lies between 0,1 and 1,0 dtex (for comparison: the fineness of cotton fibres lays between 1,5 and 2,5 dtex), the production of microfibres ist very complicated. In simple terms, homogeneous polymeres (plastic) are melted and spinned to a fibre. The regular spinning process hast to be adjusted, because microfibres only can be produced on a very high spinning speed. This high speed results to a parallel arrangement of molecules, which guarantees robustness and tear-resistency, in spite of the fibre fineness.

10.000 metres of this thin fibre only weigh 1 gram. Microfibres are three times thinner than cotton fibres and 100 times thinner than human hair. But compared with other materials they have a higher volume. As a result microfibre mops have a good dirt absorbability due to their larger surface. The thin mesh goes even in micropores of structured surfaces and therefore remove tenacious dirt easily without being prone to fluff.



Cotton

Cotton mops are made from cotton fibres (natural fibres) that are extracted from cotton plants. Normally cotton mops consist of a mixture of cotton and polyestreto avoid shrinking during washing. The diametre of a fibre is 12-35 μm .

Compared to microfibre cotton is very absorptive and kann absorb up to 65 percent of its own weight. But the drying time is much longer than for microfibres. Cotton has a high dirt and oil capacity and escaping power. Therefore cotton mops are ideal for floor cleaning and coating.



i International Agencies:

 Austria	 Poland
 Belgium	 Portugal
 Croatia	 Slovenia
 Czech Republic	 Syria
 Finland	 Turkey
 France	 Ukraine
 Great Britain	
 Greece	
 Hungary	
 Italy	
 Ireland	
 Latvia	
 Lithuania	
 Luxembourg	
 Malta	



Company Profile

An institution in the cleaning industry – over 90 years of tradition and experience

In 1923 Willy Oehme, Nuremberg, founded the Lorito S.A. in Vevey, Switzerland, at the Lake Geneva. At that time the range of products was limited to the Creme Lorito, a universal cleaning agent for the “housewife” to clean, polish and disinfect wood, leather, linoleum and other Types of solid surfaces. The creme is produced to this day.

In 1970 his son Otto Oehme (top right picture) took over the company that now had its place of business in Wendelstein south of Nuremberg. The newly founded Otto Oehme GmbH (a limited company) shifted its focus to business clients and broadened its portfolio of products gradually. In 1998 the company moved to the current premises in Allersberg that house management as well as production. For better market coverage further associated companies were founded in Berlin, Brunswick, Hannover, Leipzig and Frankfurt.

To maintain the continued existence of the company Ulla Oehme and Klaus Krisch joined management in 2003. Two years later the company expanded and multiple foreign subsidiaries were founded – at the moment the Otto Oehme GmbH is represented in more than 20 countries. Large-scale consumers in Germany and the EU are supplied by the company's own private haulage. In the meantime the range of products has been extended to additives, auxiliary equipment and machines.

In 2010 Ulla Oehme took over some company shares and is now an owner of the company as well – in the third generation by now.

Our ambition

Due to our variety of special cleaning agents and machines we offer a complete solution for cleanliness and hygiene. Our skilled consultants attend to your needs. We organize seminars for our customers, led by well-known instructors, on a regular basis.

Committed to the environment

The Otto Oehme GmbH is a member of multiple research communities and professional associations (such as IHO, IKW, VCI, FRT, ARGEB) as well as a participant in the “Environmental Pact” of Bavaria (Umweltpakt Bayern). Since 1923 all compositions of cleaning agents and care products have always been produced in-house. They are free of CFC, chlorocarbons and aromatic solvents. In order to meet our ecological and economic obligations, we use renewable raw materials wherever possible.

Furthermore, all of our cleaning agents comply with legal regulations by directive 1999/45/EC of the EU (relating to the classification, packaging and labelling of dangerous preparations), the German Detergent and Cleaning Agent Act (Wasch- and Reinigungsmittelgesetz – WRMG, 1987), the German Chemicals Act (Chemikaliengesetz – ChemG, revision 2002) and Hazardous Substances Ordinance (Gefahrstoffverordnung – GefStoffV, 2010).

That means that our products – when used properly – will not endanger the physical health of a person. The forceful legislation of the EU, particularly the Regulation on Registration, Evaluation, Authorisation and Restriction of Chemicals (REACH), that makes special demands on environmental protection as well as health protection, is strictly adhered to at all times.

If procurable we outrun these legal guidelines and offer our customers products with maximal environmental sustainability and user protection. Thus, for example, we offer products following Decision 2005/344/EC by the EU, a regulation for the EU Ecolabel. For these products an environmental assessment process according to a special questionnaire is no longer necessary. Our disinfectants are listed by the Association for Applied Hygiene (Verband angewandter Hygiene – VAH, former DGHM), several sanitary cleaners are included in the RK-list.

Please get in touch with us, we gladly advise you.

Your Otto Oehme GmbH

Imprint

Published by:

Otto Oehme GmbH
Industriestr. 20
90584 Allersberg
Germany
Tel: +49 (0) 9176 / 98 05 0
Fax: +49 (0) 9176 / 98 05 55
E-mail: info@oehme-lorito.de

HRB 4318, Amtsgericht Nürnberg
VATIN: DE 133 531 484
Court of jurisdiction: 91126 Schwabach

Responsible for content: Otto Oehme GmbH
Editor: Carlos Oehme
Design & layout: fp360 new media

Associated Companies:

Berlin
Otto Oehme GmbH
Lorito Vertrieb Berlin
Meeraner Str. 13 f
12681 Berlin, Germany
Tel: +49(0) 30 / 559 686 4
Fax: +49(0) 30 / 550 959 5
E-mail: info@oehme-berlin.de

Leipzig
Otto Oehme GmbH
Lorito Vertrieb Leipzig
Lindenthaler Hauptstr. 135
04158 Leipzig, Germany
Tel: +49(0) 341 / 234 196 0
Fax: +49(0) 341 / 234 196 1
E-mail: lorito-leipzig@gmx.de

Brunswick
Sefin Lorito Vertriebs GmbH
Marienberger Straße 1
38122 Braunschweig, Germany
Tel: +49(0) 531 / 871 902
Fax: +49(0) 531 / 871 990
E-mail: info@sefin.de

Frankfurt
Otto Oehme GmbH
Lorito Vertrieb Frankfurt
Oberurseler Straße 73
61440 Oberursel, Germany
TEL: +49 (0) 176 / 311 145 99
FAX: +49 (0) 6171 / 507 731
E-mail: klaus.peiner@gmx.de

Index

Adaptor for Hitachi nozzles	39	Mopping carts	12-16
Aluminium sticks	20	Multipurpose tools	39
		Nozzles	39
Bin liner	19	Pads	18
Blade holder	8	Paper bin	24
Blades	8	Paper dispenser	24
Brooms	20	Paper filters	40
Broom sticks	20	Paper towels	24
Brushes	20	Parquet tools	39
Buckets	19	Plastic bags/sacks	19
Bucket system carts	12-15	Plastic buckets	24
		Polishing machines	42
		Power cable	40
Cartridges for soap dispenser	25	Quiver for tools	8
Caution signs	22	Roll press system	16, 19
Ceiling brushes	21	Rubber strips for window cleaners	8
Cleanfix machines	45, 46	Sanitary brushes	21
Cleaning machines	42-46	Scratcher	8
Cleaning trolleys	28-30	Scrubber dryers	45-46
Cleansing tissues	24	Shoe pads	18
Combined floor tool	39	Single disc machines	42-43
Crevice nozzle	39	Skin care creme	26
Deodorizer clips	24	Soap dispensers	25
Dirt eraser Pumie	26	Special mops	10-11
Disinfectant trough	19	Spiral scouring pad	18
Double bucket system trolleys	14, 15	Sponges	18
Dust cloths	8, 18	Spray extraction machines	44
Dustpan	21	Spray can	22
		Suction tubes	40
Feather duster	21	Superpads	18
Fleeze cloths	18	System carts	28-30
Floor tools	39		
Foam soap dispenser	25	Telescopic sticks	8
Folding flat mop frames	11	Toilet brush	26
Fork mop	22	Toilet paper	24
Funnel tube	26	Tool handles	20
		Towels	8, 18
Gaze cloths	9	Trolleys	28-32
Glass scraper	8	Troughs	19
Gloves	22	Turbo nozzles	39
		Two-chamber mopping cart	16
Handpad	18	Urinal deodorizer	24
Heater brush	21	Vacuum cleaners	34-35
Hose sets	39	Washer sleeves	8
Hotel trolleys	31	Waste bins	26
Hygienic paper	24	Waste picker	22
Hygienic pouches and dispenser	24	Waste trolleys	32
		Water pushers	21
Jumbo roll mount	24	Wet and dry cleaners	36-37
		Wet mops	10, 11
Kitchen rolls	24	Wet mop x-mount	9
Knapsack exhauster	38	Window cleaners	8
		Window washer holders	8
Laundry trolleys	32		
Metal scraper	22		
Microfibre mops	10-11		
Microfibre towels	18		
Moist mops	9		
Moist wiping handles	9		